

BANANA PLUGS

STANDARD BANANA PLUG

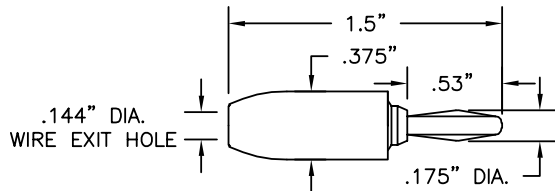

Part No.	Description
9202	Standard Banana Plug

Construction: Nylon handle. Nickel-plated brass body. Nickel silver spring. Solderless assembly.

Colors: Available in 10 colors. See inside back cover for details.

STACKING STANDARD BANANA PLUG

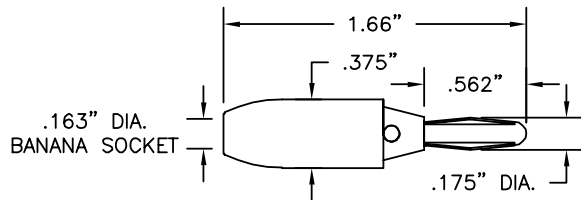

Part No.	Description
9203	Stacking Standard Banana Plug

Construction: Nylon handle. Nickel-plated brass body. Phosphor bronze spring. Solderless assembly.

Colors: Available in 10 colors. See inside back cover for details.

MINIATURE BANANA PLUG

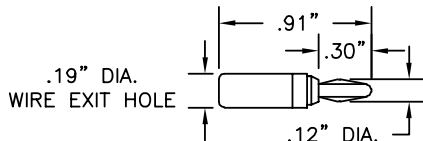

Part No.	Description
9213	Miniature Banana Plug

Construction: Plastic handle. Nickel-plated phosphor bronze body. Beryllium copper spring. Solder assembly.

Colors: Available in 10 colors. See inside back cover for details.

MINIATURE BANANA PLUG WITH 6-32 THREAD

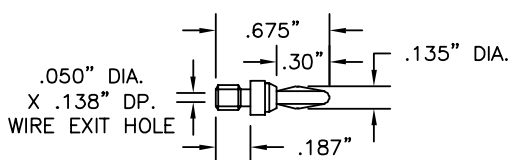

Part No.	Description
8201	Mini Banana Plug with 6-32 Thread

Construction: Nickel-plated phosphor bronze body. Beryllium copper spring. Solder assembly. Thread size 6-32.

METER BANANA PLUG

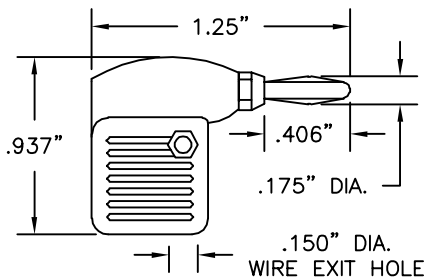

Part No.	Description
9206	Meter Banana Plug

Construction: Plastic handle. Nickel-plated brass body. Nickel-plated beryllium copper spring. Solder assembly.

Colors: Available in red and black.

BANANA PLUG FOR HEAVY WIRE

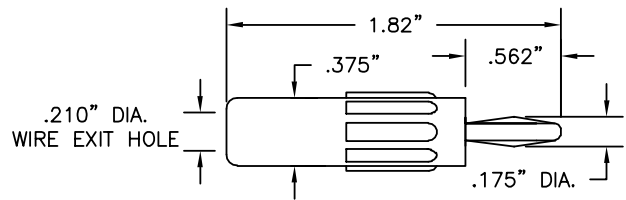

Part No.	Description
9214	Banana Plug for Heavy Wire

Construction: Plastic handle. Nickel-plated brass body. Phosphor bronze spring. Solderless assembly.

Colors: Available in red and black.

STACKING STANDARD BANANA PLUG FOR HEAVY WIRE

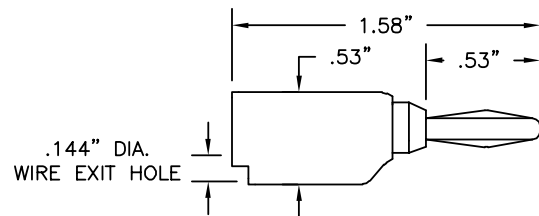

Part No.	Description
9260	Stacking Standard Banana Plug for Heavy Wire

Construction: Plastic handle. Nickel-plated brass body. Phosphor bronze spring. Snap together solderless assembly.

Colors: Available in 10 colors. See inside back cover for details.

STACKING MINIATURE BANANA PLUG

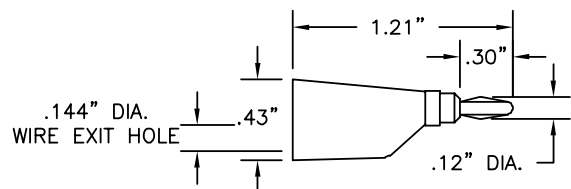

Part No.	Description
9261	Stacking Miniature Banana Plug

Construction: Plastic handle. Nickel-plated phosphor bronze body. Nickel-plated brass socket. Beryllium copper spring. Solderless assembly.

Colors: Available in 10 colors. See inside back cover for details.

STACKING SHROUDED BANANA PLUG, ACCEPTS SHROUDED BANANA PLUGS

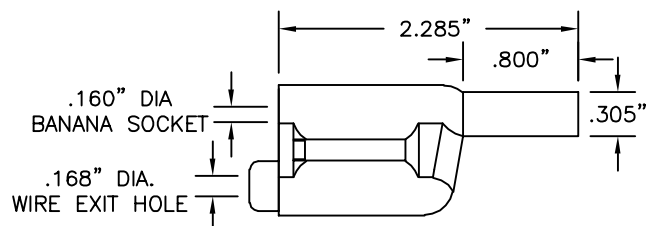

Part No.	Description
9383	Stacking Shrouded Banana Plug, Accepts Shrouded Plugs

Construction: Housing is two piece molded nylon. Banana socket & plug are a one piece machined brass section with a beryllium copper contact spring. Banana plug tip is insulated. Wire connection is solderless. (IEC 1010 Compliant)

Colors: Red, black, yellow, green, blue and white.

BANANA PLUGS

STRAIGHT SHROUDED BANANA PLUG

Part No.	Description
9386	Straight Shrouded Banana Plug

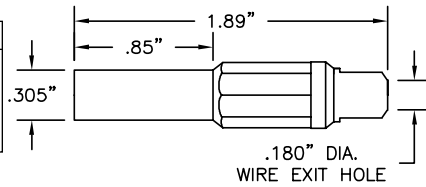

Construction: Housing is one piece molded nylon. Banana plug is machined brass with a contact spring all nickel plated. Banana plug tip is insulated. Wire connection is soldered. (IEC 1010 Compliant)

Colors: Available in red and black.

RIGHT ANGLE STANDARD BANANA PLUG

Part No.	Description
9304	Right Angle Standard Banana Plug

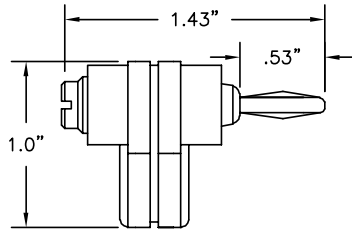

Construction: Nickel-plated brass body. Nickel-plated beryllium copper spring. Plastic handle. Solderless assembly.

Colors: Available in red and black.

SHROUDED RIGHT ANGLE STANDARD BANANA PLUG

Part No.	Description
9301	Shrouded Right Angle Standard Banana Plug

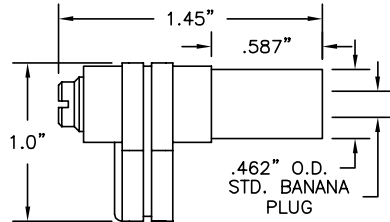

Fits most **AMPROBE** and **BECKMAN** instruments with recessed receptacles for shrouded plugs.

Construction: Nickel-plated brass body. Nickel-plated beryllium copper spring. Plastic handle. Solderless assembly.

Colors: Available in red and black.

STACKING SHROUDED RIGHT ANGLE STANDARD BANANA PLUG

Part No.	Description
9306	Stacking Shrouded Right Angle Standard Banana Plug/Socket

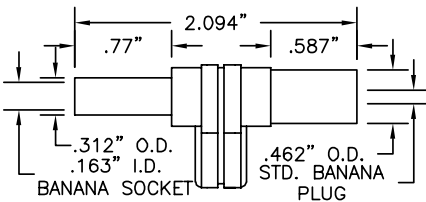

Fits most **FLUKE**, **B&K PRECISION**, **HP**, **BECKMAN**, **AMPROBE**, **METERMAN**, and **GREENLEE** instruments with recessed receptacles for shrouded plugs.

Construction: Nickel-plated brass body and socket. Nickel-plated phosphor bronze spring. Plastic handle. Solderless assembly.

Colors: Available in red and black.

STANDARD BANANA PLUG 6-32 STUD MOUNTING

Part No.	Description
8204	Standard Banana Plug

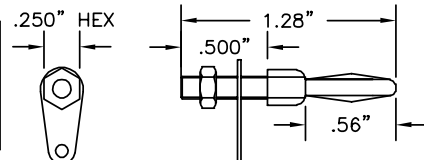

Construction: Nickel plated brass body and nut. Tinned brass solder lug. Nickel-plated beryllium copper spring.

RETRACTABLE SHROUDED BANANA PLUG

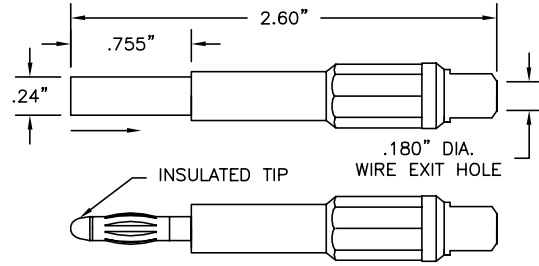

Part No.	Description
9388	Retractable Shrouded Banana Plug

Construction: Housing is a three piece molded nylon assembly with a wire collet for strain relief. Banana plug has a brass frame and beryllium copper contact spring; both are nickel plated. Wire connection is soldered. (IEC 1010 Compliant)

Colors: Black, red, yellow, green, blue and white.

STACKING RIGHT ANGLE STANDARD BANANA PLUG

Part No.	Description
9307	Stacking Right Angle Standard Banana Plug

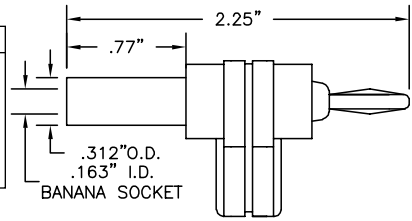

Construction: Nickel-plated brass body and socket. Nickel-plated beryllium copper spring. Plastic handle. Solderless assembly.

Colors: Available in red and black.

SHROUDED RIGHT ANGLE STANDARD BANANA PLUG

Part No.	Description
9302	Shrouded Right Angle Standard Banana Plug

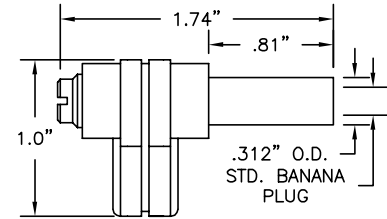

Fits most **FLUKE**, **B&K PRECISION**, **HP**, **BECKMAN**, **AMPROBE**, **METERMAN**, and **GREENLEE** instruments with recessed receptacles for shrouded plugs.

Construction: Nickel-plated brass body. Nickel-plated phosphor bronze spring. Plastic handle. Solderless assembly.

Colors: Black, brown, red, orange, yellow and violet.

STACKING SHROUDED RIGHT ANGLE STANDARD BANANA PLUG

Part No.	Description
9305	Stacking Shrouded Right Angle Std. Banana Plug/Socket

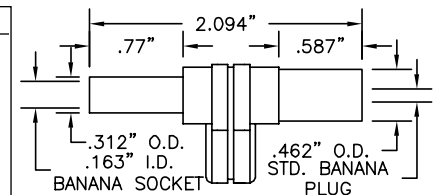

Fits most **AMPROBE**, **BECKMAN**, **SIMPSON** and **TRIPLETT** instruments with recessed receptacles for shrouded plugs.

Construction: Male: Nickel-plated brass body. Nickel-plated beryllium copper spring.

Female: Nickel-plated beryllium copper socket. Plastic handle. Solderless assembly.

Colors: Available in red and black.

STANDARD BANANA PLUG FEMALE 6-32 THREAD MOUNTED

Part No.	Description
8205	Standard Banana Plug

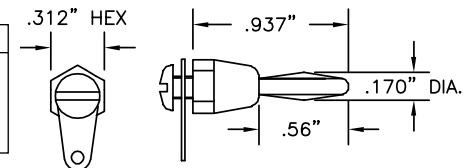

Construction: Nickel plated brass body and screw. Tinned brass solder lug. Nickel-plated beryllium copper spring. Maximum panel thickness .187".

BANANA PLUGS

NO. DB750 STACKING DOUBLE BANANA PLUG

Construction:

Nylon handle. Nickel-silver spring. Nickel-plated brass socket. Solderless assembly.

Colors: Available in red and black.

Part No.	Description
DB750	Stacking Double Banana Plug

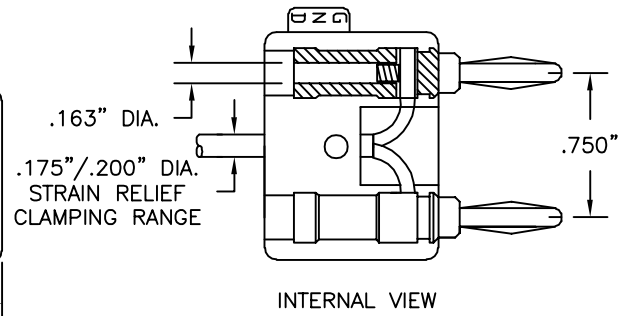
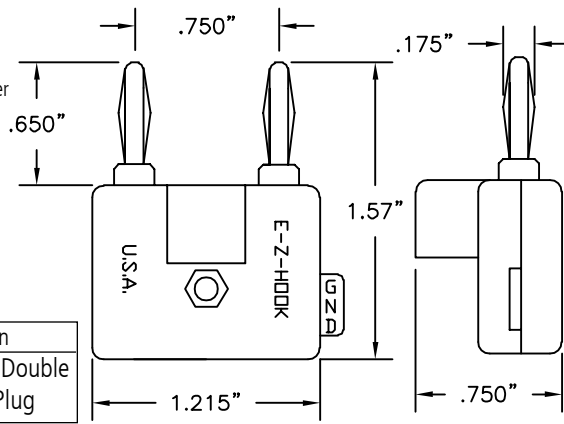

NO. DB500 STACKING MINIATURE DOUBLE BANANA PLUG

Construction:

Nylon handle. Beryllium copper spring. Music wire socket, nickel-plated. Solderless assembly.

Colors: Available in red and black.

Part No.	Description
DB500	Stacking Double Mini Banana Plug

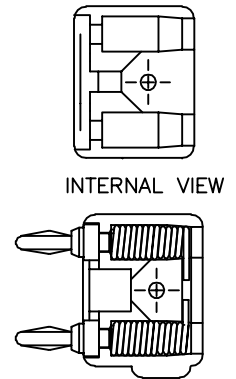
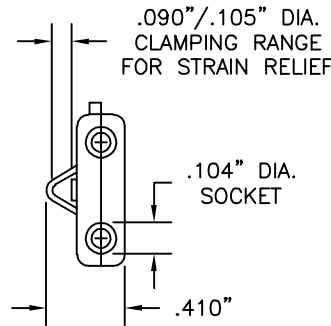
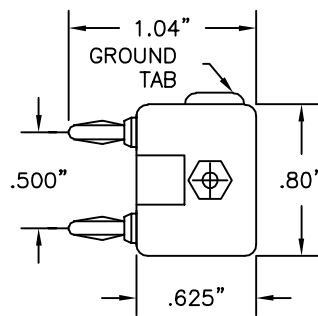

INSULATED SPADE LUGS

.250" (6.35mm) INSULATED SPADE LUG

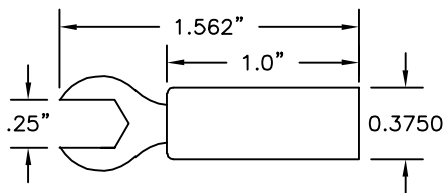

Part No.	Description
9208	.250" Spade Lug

Construction: Plastic handle; .050" (1.27mm) thick nickel plated brass lug. Solder assembly.

Colors: Available in red and black.

.140" (3.57mm) INSULATED SPADE LUG

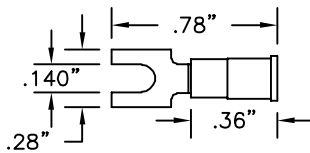

Part No.	Description
9209	.140" Spade Lug for AWG22 to 18 Lead

Insulation Maximum: .150" (3.81mm)

For No. 6 Screw—.140" (3.55mm)

Construction: Vinyl insulator. Tin-plated copper lug. Crimp on assembly.

Colors: Red.

SPADE LUG TO BANANA SOCKET, ACCEPTS SHROUDED BANANA PLUGS

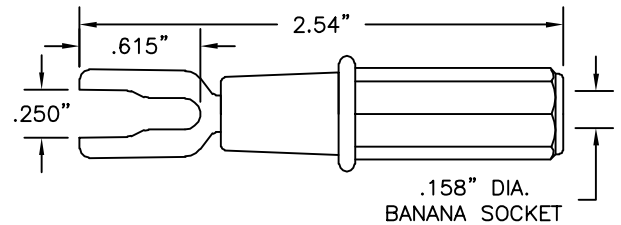

Part No.	Description
9385	Spade Lug (fits .25" and #8) to Banana Socket

Construction: Nylon handle. Banana socket and spade lug are nickel-plated brass.

Colors: Black, red, yellow, green, blue and white.

.250" (6.35mm) INSULATED SPADE LUG TO STD. BANANA SOCKET

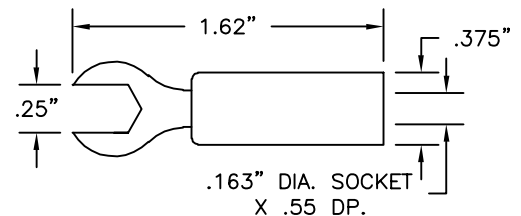

Part No.	Description
8020-(color)	.250" Insulated Spade Lug to Std. Banana Socket

Construction: Housing is molded nylon; banana socket is machined brass; spade lug is brass, both are nickel-plated.

Colors: Available in red and black.

BANANA SOCKETS

STANDARD BANANA SOCKET

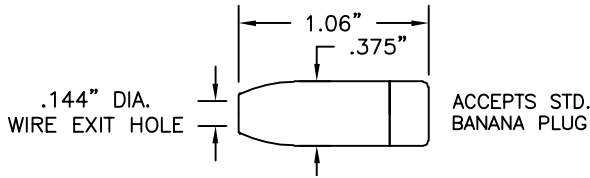

Part No.	Description
9210	Standard Banana Socket

Construction: Nylon handle. Nickel-plated brass socket. Solder assembly.
Colors: Available in 10 colors. See inside back cover for details.

MINIATURE BANANA SOCKET

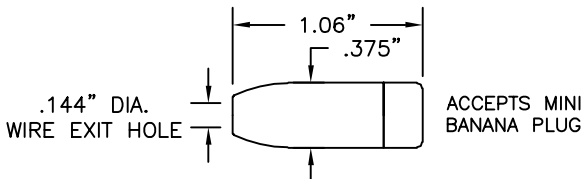

Part No.	Description
9252	Miniature Banana Socket

Construction: Nylon handle. Nickel-plated brass socket. Solder assembly.
Colors: Available in 10 colors. See inside back cover for details.

STANDARD BANANA SOCKET FEMALE 6-32 THREAD MOUNTED

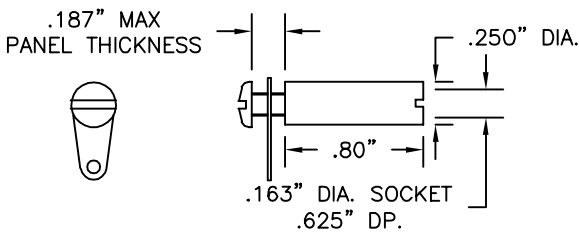

Part No.	Description
8206	Standard Banana Socket

Construction: Nickel-plated brass body and screw. Tinned brass solder lug.

SHROUDED BANANA SOCKET, ACCEPTS SHROUDED BANANA PLUGS

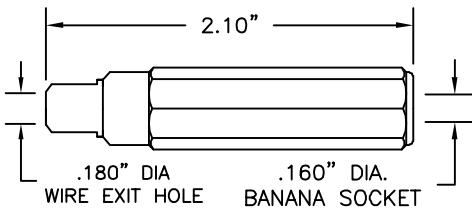

Part No.	Description
9387	Shrouded Banana Socket, Accepts Shrouded Plugs

Construction: Housing is a two piece molded nylon assembly with a wire collet for strain relief. The banana socket is nickel-plated brass. Wire connection is soldered.
Colors: Black, red, yellow, green, blue and white.

BANANA SOCKET ADAPTER

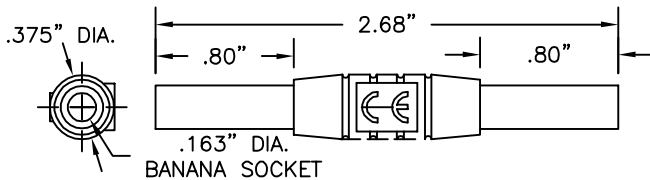

Part No.	Description
9430	Banana Socket Adapter

Accepts standard and shrouded banana plugs. Ideal for lead extension.
Colors: Available in red and black.

STANDARD BANANA SOCKET WITH LONG BODY AND LARGE WIRE EXIT HOLE TO ACCOMODATE HEAVY WIRE

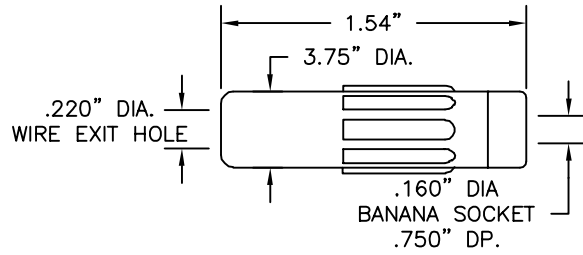

Part No.	Description
9251	Standard Banana Socket with Long Body

Construction: Plastic handle. Nickel-plated brass socket. Solder assembly.
Colors: Available in red and black.

SHROUDED RIGHT ANGLE STANDARD BANANA SOCKET

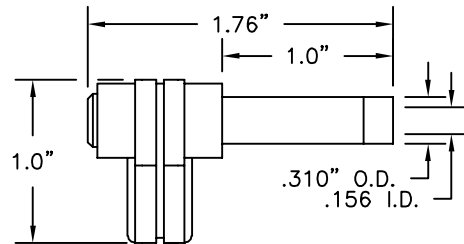

Part No.	Description
9309	Shrouded Right Angle Standard Banana Socket

Fits most **SIMPSON** and **TRIPLETT** instruments with recessed plugs for shrouded receptacles.

Construction: Nickel-plated beryllium copper spring socket. Plastic handle. Solderless assembly.
Colors: Available in red and black.

E-Z-FLEX™ TEST ADAPTERS

PART NO.	AWG	CONTACT DIA.	TYPE OF CONTACT
9334 (color)	22	.030" (.762mm)	Socket
9338 (color)	22	.030" (.762mm)	Pin
9335 (color)	20	.040" (1.02mm)	Socket
9339 (color)	20	.040" (1.02mm)	Pin
9336 (color)	16	.062" (1.60mm)	Socket
9340 (color)	16	.062" (1.60mm)	Pin
9337 (color)	12	.094" (2.36mm)	Socket
9341 (color)	12	.094" (2.36mm)	Pin

DESCRIPTION: Banana socket end is brass tin plated. All the contact ends are gold plated. The flexible insulation is molded plastic. Socket accepts standard banana plugs.
Colors: Available in red and black.

