



Monnit Wi-Fi Magnetic Sensor

Technical Overview



General Description

The Monnit Wi-Fi Magnetic Sensor can be used to detect the presence of a magnetic source. Place a magnet strip on a motor or machinery to measure movement and placement. An integrated 802.11 b/g radio allows the sensor to work with any existing Wi-Fi network. Monnit Wi-Fi sensors can be easily programmed with your Wi-Fi network's WEP or WPA(2) security via the free MoWi Setup Utility (PC application) and a MoWi USB programming cable (available in the [Monnit web store](#)).

Features

- Detects when a magnet is present.
- Magnet is included.
- Logs data if Wi-Fi network is disrupted.
- Free iMonnit basic online wireless sensor monitoring and notification system to configure sensors, view data and set alerts via SMS text and email.

Principle of Operation

The Monnit Wi-Fi Magnetic Sensor uses a wired reed switch to detect the presence or removal of a magnetic source. When the sensor detects that the magnet is removed or returned it sends the information to the iMonnit Online Sensor Monitoring and Notification System. The data is stored in the online system and can be reviewed and exported as a data sheet or graph. Notifications can be set up through the online system to alert the user when a magnetic source is present or not with the ability to only notify within time of day parameters.

High Gain Antenna Option

Monnit Wi-Fi sensors are also available with a detachable high gain antenna to provide a 20-30% increase in range over the standard Wi-Fi sensor. Option uses a different hardware configuration and must be chosen at time of purchase.



Monnit Wi-Fi Sensor Electronics Specifications

- Power: 2 replaceable 1.5V "AA" batteries (included)
- Communication: 802.11 b/g
(2.412 - 2.484 GHz)
- Wi-Fi Security: Open, WEP, WPA, WPA2
- Dimensions: 3.02" x 2.1" x 1.27"
- Transmission Range: Up to 250 ft. *
- Battery Life: Up to 5 years.**

* Actual range may vary depending on environment.
** Battery life is affected by sensor type, Wi-Fi security type, distance from Wi-Fi router, reporting frequency and other variables.

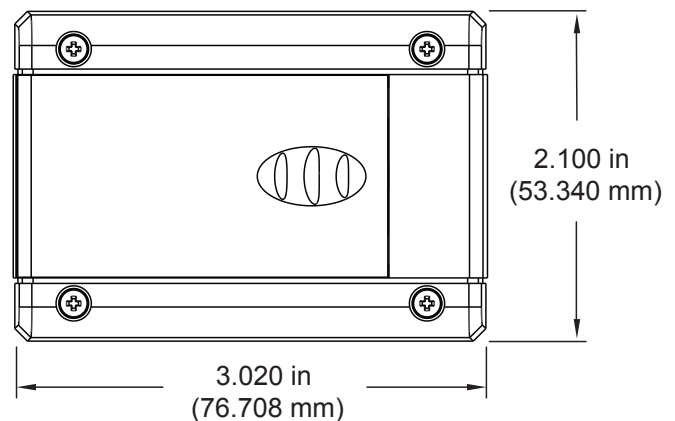

Height: 1.270 in (32.258 mm)



Applications

- Doors and windows.
- Production line tracking.
- Machine RPM tracking.

The Leader in Low Cost Wireless Sensors

Technical Specifications	
Networking Standards	IEEE 802.11 b/g
Frequency Band	2.412 - 2.484 GHz
Wi-Fi Security Standards	Open, WEP, WPA, WPA2
Wi-Fi Security Programming	Via PC software using USB cable. (Can be changed through iMonnit online software.)
Network Settings	Auto DHCP/DNS or Static
Data Logging	Standard - On Wi-Fi disruption, unit will log the first 50 readings and transmit when Wi-Fi connection is re-established. Premiere - Unit can record up to 50,000 readings and transmit when Wi-Fi is available.
Power consumption	4uA sleep, 35mA active RX, 180mA TX (at +12dBm)
Battery Life	Up to 5 years depending on sensor type, Wi-Fi security, distance from Wi-Fi router, reporting frequency and other variables. (Testing surpassed 90,000 transmissions until battery depletion.)
Wi-Fi Data Rate	Auto configures to best rate for maximum range.
Wireless Range	Up to 250 ft. device range (typical to standard Wi-Fi devices).
Electronics Operating Temperature	Using Alkaline Batteries: -18°C to +55°C (0°F to +130°F) Using Lithium Batteries: -40°C to +85°C (-40°F to +185°F)
LED Light	Status / activity
Certifications	   FCC ID: T9J-RN171. IC: RSS-210 low-power communication device. CE ID: 0681.

Magnetic Switch Specifications	
Operation Time	0.5 ms (max)
Release Time	0.1 ms (max)
Shock	11ms ½ sine wave / 100 g (max)
Vibration	50 - 2000 Hertz / 30 g (max)
Resonant Frequency	8500 Hz (typ)
Pull-In Range	10 - 25 Ampere Turns
Rating Sensitivity	15 Ampere Turns

* Hardware cannot withstand negative voltage. Please take care when connecting a power device.

** At temperatures above 100°C, it is possible for the board circuitry to lose programmed memory.

Caution/Notice:

This product is designed for application in an ordinary environment (normal room temperature, humidity and atmospheric pressure). Do not use this sensor under the following conditions as these factors can deteriorate the product characteristics and cause failures and burn-out.; corrosive gas or deoxidizing gas - chlorine gas, hydrogen sulfide gas, ammonia gas, sulfuric acid gas, nitric oxides gas, etc.), volatile or flammable gas, dusty conditions, under low or high pressure, wet or excessively humid locations, places with salt water, oils chemical liquids or organic solvents, where there are excessively strong vibrations, other places where similar hazardous conditions exist.

Use this product within the specified temperature range. Higher temperature may cause deterioration of the characteristics or the material quality of this product.

For more information about our products or to place an order, please contact our sales department at 801-561-5555 or visit us on the web at www.monnit.com.



Monnit Corporation
4403 South 500 West
Murray, UT 84123
801-561-5555
www.monnit.com