

BANTAM PHONE PLUG TEST CABLES

Details: The frame is nickel plated machined brass. All internal insulation is injection molded nylon. The handle is a black molded flexible rubber cover. All connections are soldered.

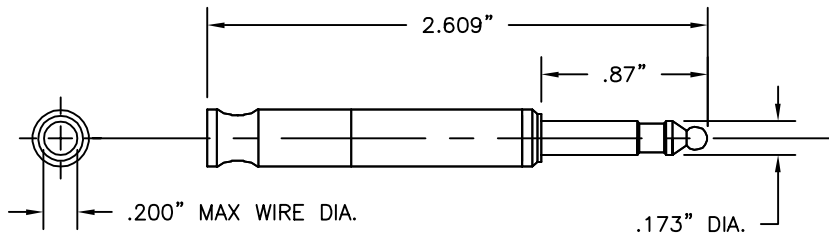

Part No.	Description
9320	Bantam Plug

PATCH CORD BANTAM PLUG TO BANTAM PLUG

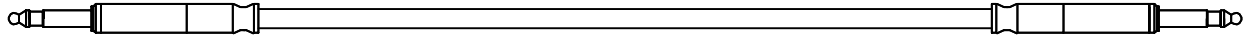

Standard Lengths Available:

Part No.	Cable
2626-(length)	2200 Series

18"	45cm	36"	90cm
24"	60cm	48"	120cm
30"	75cm	60"	150cm

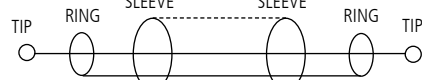

E-Z-MICRO-HOOKS TO BANTAM PHONE PLUG

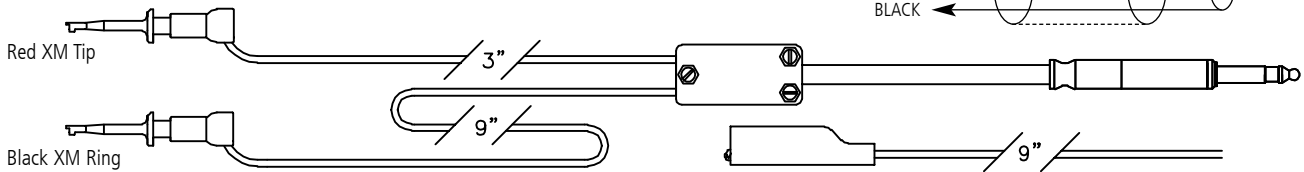

Cable with XM Ring

Part No.	Cable	Tip	Ring
2620XM-(lgth)	2200 Series	XM	XM

Cable With Part No. 9275 Miniature Alligator Ring

Part No.	Cable	Tip	Ring
2621XM-(lgth)	2200 Series	XM	Mini Gator

E-Z-MINI HOOKS TO BANTAM PHONE PLUG

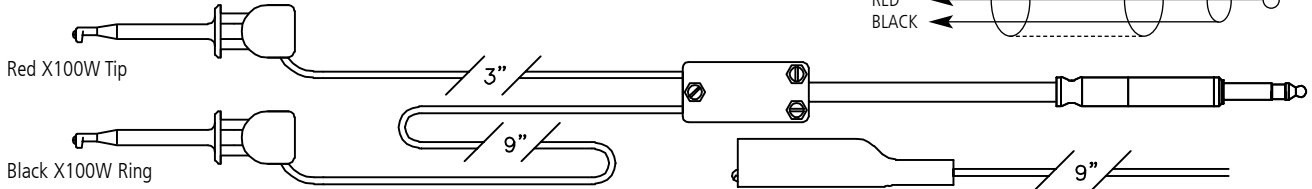

Cable with X100W Ring

Part No.	Cable	Tip	Ring
2620-(lgth)	2200 Series	X100W	X100W

Cable With Part No. 9274 Standard Alligator Ring

Part No.	Cable	Tip	Ring
2621-(lgth)	2200 Series	X100W	Std. Gator

E-Z-MINI XR HOOKS TO BANTAM PHONE PLUG

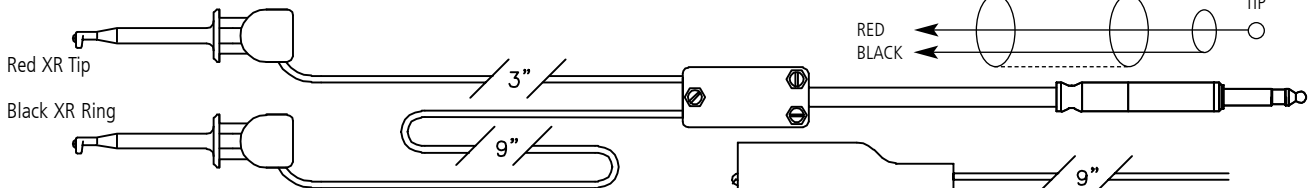

Cable with XR Ring

Part No.	Cable	Tip	Ring
2620XR-(lgth)	2200 Series	XR	XR

Cable With Part No. 9274 Standard Alligator Ring

Part No.	Cable	Tip	Ring
2621XR-(lgth)	2200 Series	XR	Std. Gator

BANTAM PHONE PLUG TEST CABLES

DOUBLE GRIPPER TO BANTAM PHONE PLUG

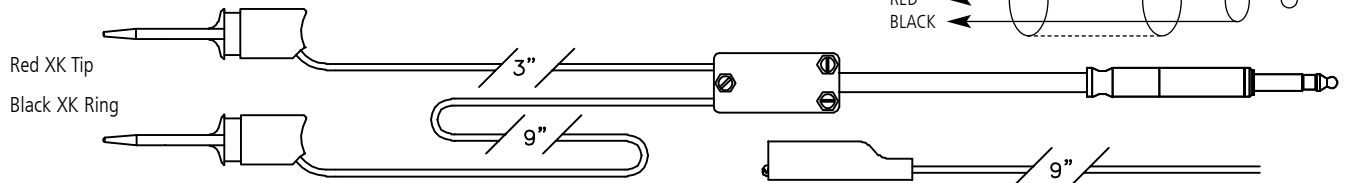

Cable With XK Ring

Part No.	Cable	Tip	Ring
2620XK -(lgth)	2200 Series	XK	XK

Cable With Part No. 9275 Miniature Alligator Ring

Part No.	Cable	Tip	Ring
2621XK -(lgth)	2200 Series	XK	Mini Gator

ALLIGATOR CLIPS TO BANTAM PHONE PLUG

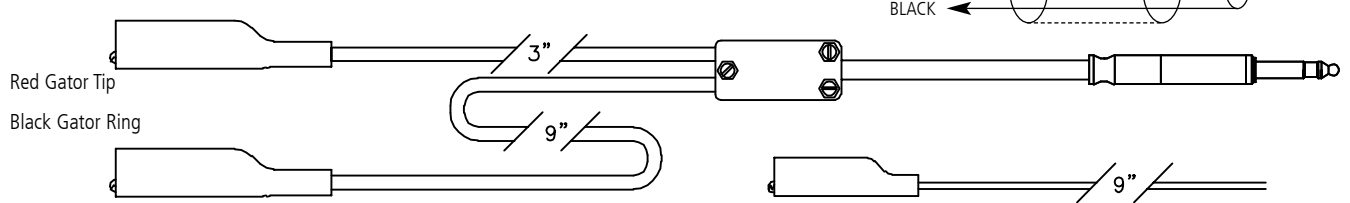

Cable With Part No. 9274 Standard Alligators and 18 AWG Leads

Part No.	Cable	Tip	Ring
2629 -(lgth)	2200 Series	Std. Gator	Std. Gator

Cable With Part No. 9275 Miniature Alligator Ring and 20 AWG Leads

Part No.	Cable	Tip	Ring
2629M -(lgth)	2200 Series	Mini Gator	Mini Gator

THREE ALLIGATOR CLIPS TO BANTAM PHONE PLUG

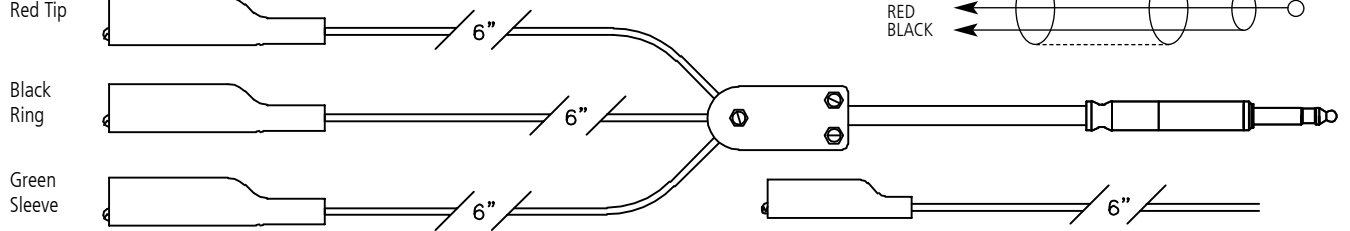

Cable With Part No. 9274 Standard Alligators

Part No.	Cable	Tip	Ring	Sleeve
2628 -(lgth)	2200 Series	Std. Gator	Std. Gator	Std. Gator

Cable With Part No. 9275 Miniature Alligators

Part No.	Cable	Tip	Ring	Sleeve
2628M -(lgth)	2200 Series	Mini Gator	Mini Gator	Mini Gator

SHIELDED BALANCE LINE, DOUBLE BANANA PLUGS TO BANTAM PHONE PLUG

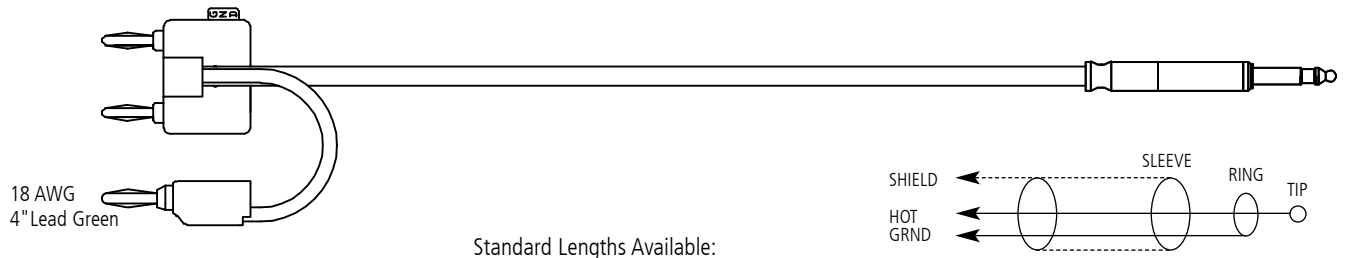

18 AWG
4" Lead Green

Standard Lengths Available:

Part No.	Cable
2605 -(Length)	2200 Series

18"	45cm	36"	90cm
24"	60cm	48"	120cm
30"	75cm	60"	150cm

1/4" PHONE PLUG (WE-310 / PJ051) TEST CABLES

Details: 1/4" Phone Plug is a functional equivalent to both the WE-310 and PJ-051. Frame is machined brass. All internal insulation is injection molded nylon. A red or black zinc die cast handle is also part of a chuck-type strain-relief clamp that accepts cables from .100" to .280" in diameter. Internal connections are soldered.

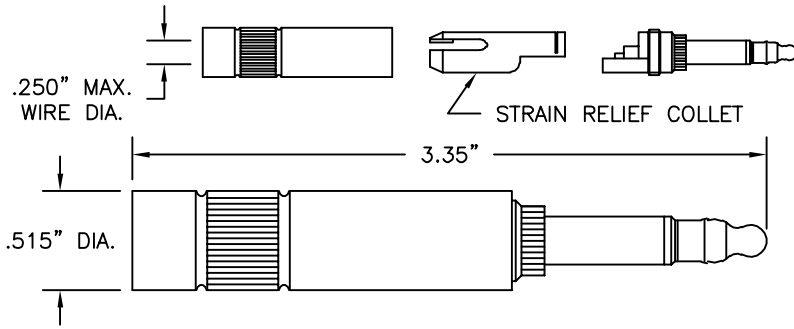

Part No.	Description
9322-(color)	Phone Plug

PATCH CORD WE-310 PHONE PLUG EACH END (PJ-051 Equivalent)

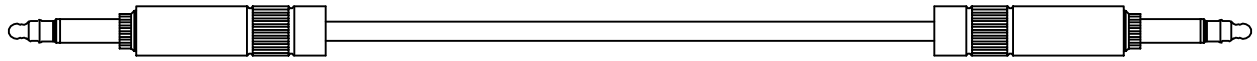

Standard Lengths Available:

Part No.	Cable
2502-(lgth)	2100 Series

18"	45cm	36"	90cm
24"	60cm	48"	120cm
30"	75cm	60"	150cm

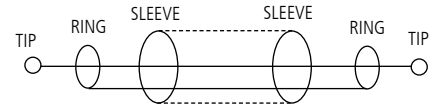

E-Z-MICRO-HOOKS TO WE-310 PHONE PLUG (PJ-051 EQUIVALENT)

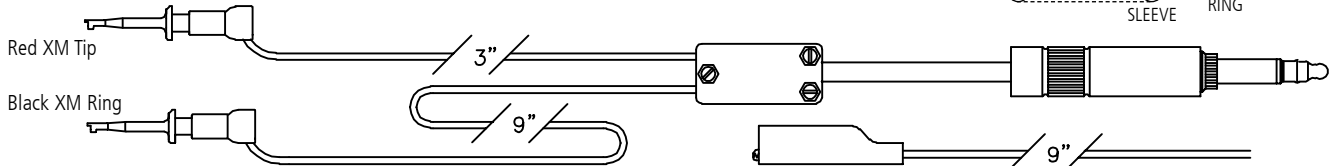

Cable with XM Ring

Part No.	Cable	Tip	Ring
2520XM-(lgth)	2100 Series	X100W	X100W
3020XM-(lgth)	Twisted Pair	X100W	X100W

Cable with Part No. 9275 Miniature Alligator Ring

Part No.	Cable	Tip	Ring
2521XM-(lgth)	2100 Series	XM	Mini Gator
3021XM-(lgth)	Twisted Pair	XM	Mini Gator

E-Z MINI HOOKS TO WE-310 PHONE PLUG (PJ-051 EQUIVALENT)

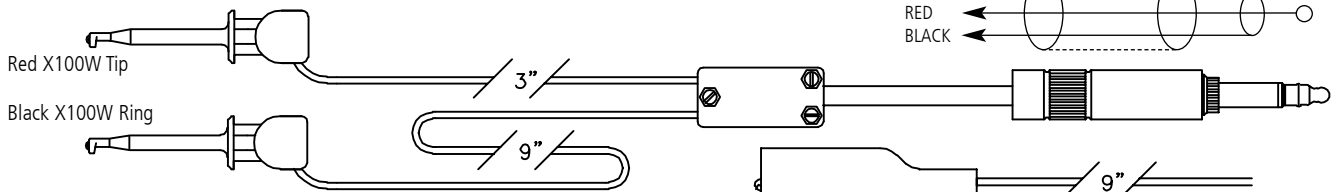

Cable with X100W Ring

Part No.	Cable	Tip	Ring
2520-(lgth)	2100 Series	X100W	X100W
3020-(lgth)	Twisted Pair	X100W	X100W

Cable with Part No. 9274 Standard Alligator Ring

Part No.	Cable	Tip	Ring
2521-(lgth)	2100 Series	X100W	Std. Gator
3021-(lgth)	Twisted Pair	X100W	Std. Gator

E-Z MINI XR HOOKS TO WE-310 PHONE PLUG (PJ-051 EQUIVALENT)

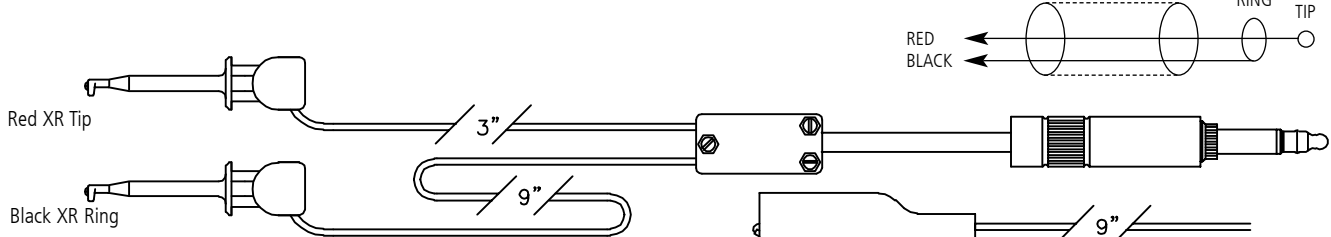

Cable with XR Ring

Part No.	Cable	Tip	Ring
2520XR-(lgth)	2100 Series	XR	XR
3020XR-(lgth)	Twisted Pair	XR	XR

Cable with Part No. 9274 Standard Alligator Ring

Part No.	Cable	Tip	Ring
2521XR-(lgth)	2100 Series	XR	Std. Gator
3021XR-(lgth)	Twisted Pair	XR	Std. Gator

1/4" PHONE PLUG (WE-310 / PJ051) TEST CABLES

DOUBLE GRIPPER TO WE-310 PHONE PLUG (PJ-051 EQUIVALENT)

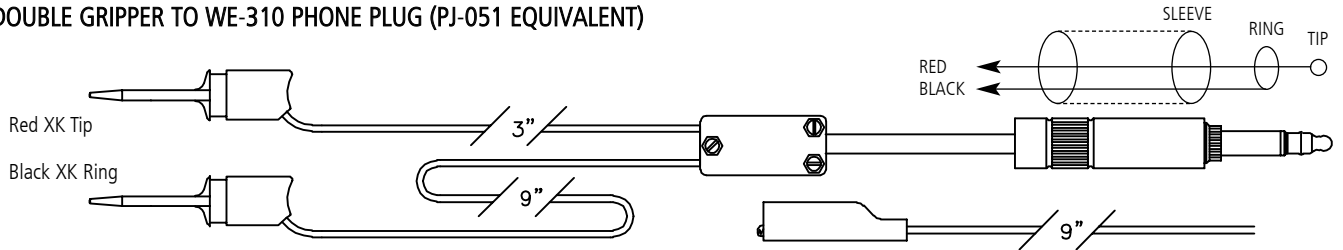

Cable with XK Ring

Part No.	Cable	Tip	Ring
2520 XK-(lgth)	2100 Series	XK	XK
3020 XK-(lgth)	Twisted Pair	XK	XK

Cable with Part No. 9275 Miniature Alligator Ring

Part No.	Cable	Tip	Ring
2521 XK-(lgth)	2100 Series	XK	Mini Gator
3021 XK-(lgth)	Twisted Pair	XK	Mini Gator

ALLIGATOR CLIPS TO WE-310 PHONE PLUG (PJ-051 EQUIVALENT)

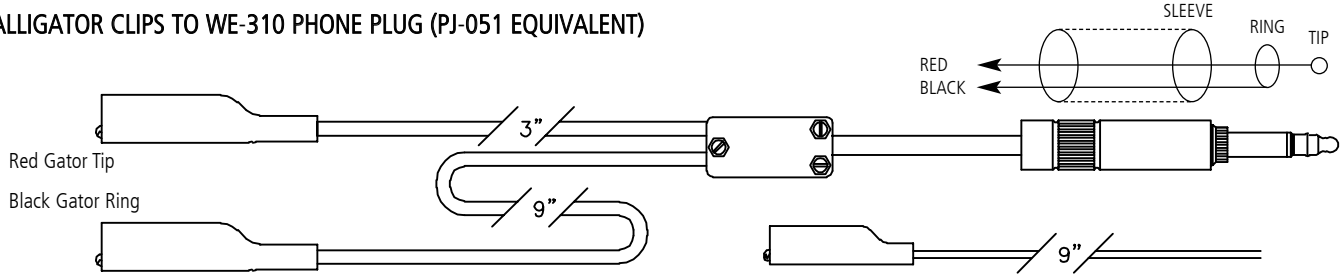

Cable with Part No. 9274 Standard Alligators and 18 AWG Leads

Part No.	Cable	Tip	Ring
2529-(lgth)	2100 Series	Std. Gator	Std. Gator
3029-(lgth)	Twisted Pair	Std. Gator	Std. Gator

Cable with Part No. 9275 Miniature Alligator Ring and 20 AWG Leads

Part No.	Cable	Tip	Ring
2529 M-(lgth)	2100 Series	Mini Gator	Mini Gator
3029 M-(lgth)	Twisted Pair	Mini Gator	Mini Gator

THREE ALLIGATOR CLIPS TO WE-310 PHONE PLUG (PJ-051 EQUIVALENT)

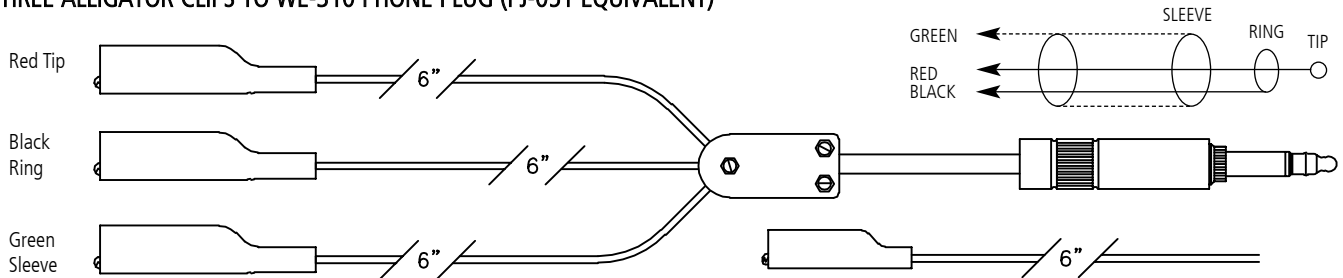

Cable with Part No. 9274 Standard Alligators

Part No.	Cable	Tip	Ring	Sleeve
2528-(lgth)	2100 Series	Std. Gator	Std. Gator	Std. Gator

Cable with Part No. 9275 Miniature Alligators

Part No.	Cable	Tip	Ring	Sleeve
2528 M-(lgth)	2100 Series	Mini Gator	Mini Gator	Mini Gator

SHIELDED BALANCE LINE, DOUBLE BANANA PLUGS TO WE-310 PHONE PLUG (PJ-051 EQUIVALENT)



18 AWG
4" Lead Green

Standard Lengths Available:

Part No.	Cable
2503-(lgth)	2200 Series

18"	45cm	36"	90cm
24"	60cm	48"	120cm
30"	75cm	60"	150cm