

E-Z-MACRO-HOOK, INSULATION-PIERCING: XJ & XJL

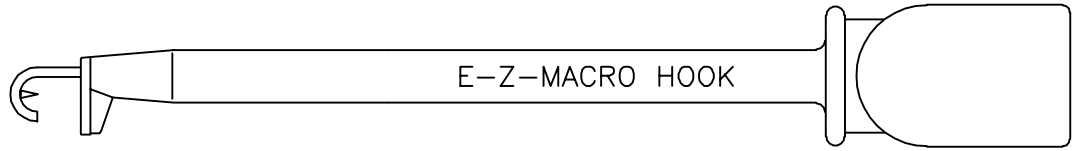

XJL MODEL

Heavy-duty insulation-piercing test hook. Spring loaded and insulated to a single contact point to assure true readings.

Actual Size

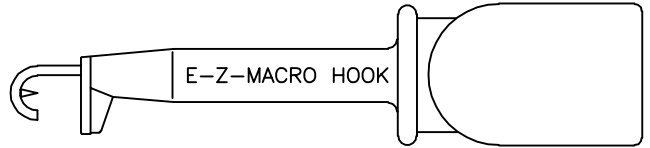

XJ MODEL

Part Number	Description
XJ (color)	Macro-Hook XJ Test Connector
XJL-(color)	Macro-Hook XJL Test Connector, Long

Construction: Nickel silver conductor and hook, .050" (1.27mm) thick. Hook fits over component leads up to .140" (3.56mm) diameter. Durable nylon body and plunger. Stainless steel compression coil spring provides approximately 40 ounces (1134 grams) contact pressure.

Part is field serviceable (see page 1).

Colors: Available in 10 colors. See inside back cover for details.

XJ MODEL

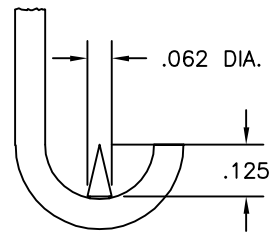
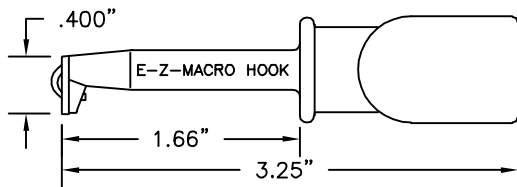

EXTENDED HOOK DETAIL
4X ACTUAL SIZE

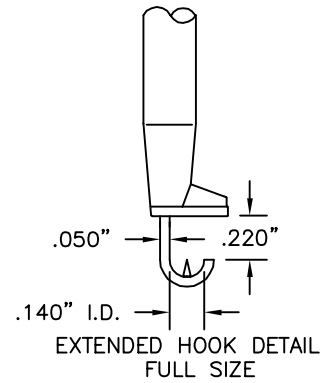

EXTENDED HOOK DETAIL
FULL SIZE

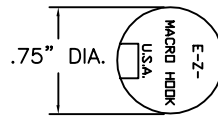
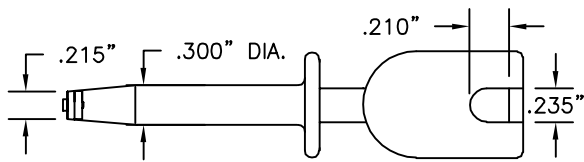

XJL MODEL

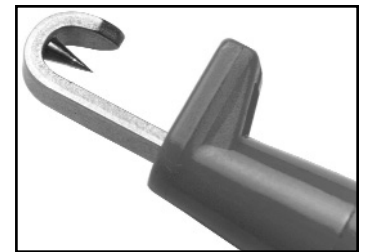

See our Automotive Kits featuring the XJL hook, page 114.

