

RELAY-2

PERIPHERAL RELAY BOARD

Technical Manual

Document Revision: 1.01

Date: 19 January, 2003



BiPOM Electronics, Inc.

16301 Blue Ridge Road, Missouri City, Texas 77489
Telephone: 1-713-283-9970 Fax: 1-281-416-2806
E-mail: info@bipom.com
Web: www.bipom.com

Overview

Peripheral relay board RELAY-2 is an Expander board for the MINI-MAX/51, MINI-MAX/908 and PRO-MAX series of micro-controller boards.

RELAY-2 has two ultra-miniature power relays. High contact capacity: 10A. Any from 11 control signals can be used to drive the relays. There are 12 jumpers on the board to choose a control port pin. Two relay terminal blocks provide the relay contacts for user needs.

RELAY-2 board should be powered from 5 Volts DC of external power source through the 20-pin I/O connector.

Specifications

RELAY-2 board has the following configuration:

- 2 ultra-miniature power relays (JS1-5V).
- 2 3-pin relay terminal blocks.
- HEX buffer (74LS07).
- Configuration selector (JP1..JP12 jumpers)
- 20-pin connector to a variety of micro-controller boards.
- Single operating voltage 5V.
- Dimensions are 2.35 X 2.40 inches (5.97 X 6.10 centimeters).
- Mounting holes of 0.138 inches (3.5 millimeters) are on four corners.
- 0° - 70° C operating, -40° - +85° C storage temperature range.

WARRANTY:

BiPOM Electronics warrants RELAY-2 for a period of 1 year. If the board becomes defective during this period, BiPOM Electronics will at its option, replace or repair the board. This warranty is voided if the product is subjected to physical abuse or operated outside stated electrical limits. BiPOM Electronics will not be responsible for damage to any external devices connected to RELAY-2. BiPOM Electronics disclaims all warranties express or implied warranties of merchantability and fitness for a particular purpose. In no event shall BiPOM Electronics be liable for any indirect, special, incidental or consequential damages in connection with or arising from the use of this product. BiPOM's liability is limited to the purchase price of this product.

© 2001 by BiPOM Electronics. All rights reserved.

RELAY-2 Peripheral Relay Board Technical Manual. No part of this work may be reproduced in any manner without written permission of BiPOM Electronics.

Expansion bus

The 16 control pins and 5 Volt power supply pins are available on the 20-pin connector (J1) for interfacing to existing micro-controller boards. RELAY-2 board can be connected to a host board either as a piggyback daughter-board using standoffs or can be placed away from the host board using a 20-wire ribbon cable (Part #: EXPCABLE-6). Table 1 shows the pin assignments for the connector.

Input Connector (J1)

Signal	Pin	Pin	Signal
P3.0	20	19	P3.1
P3.2	18	17	P3.3
P3.4	16	15	P3.5
P3.6	14	13	P3.7
P1.0	12	11	P1.1
P1.2	10	9	P1.3
P1.4	8	7	P1.5
P1.6	6	5	P1.7
VCC (+5V)	4	3	GND
VCC (+5V)	2	1	GND

Table 1

Board Layout

Figure 1 shows positions of major components, connectors and terminals on the RELAY-2 board.

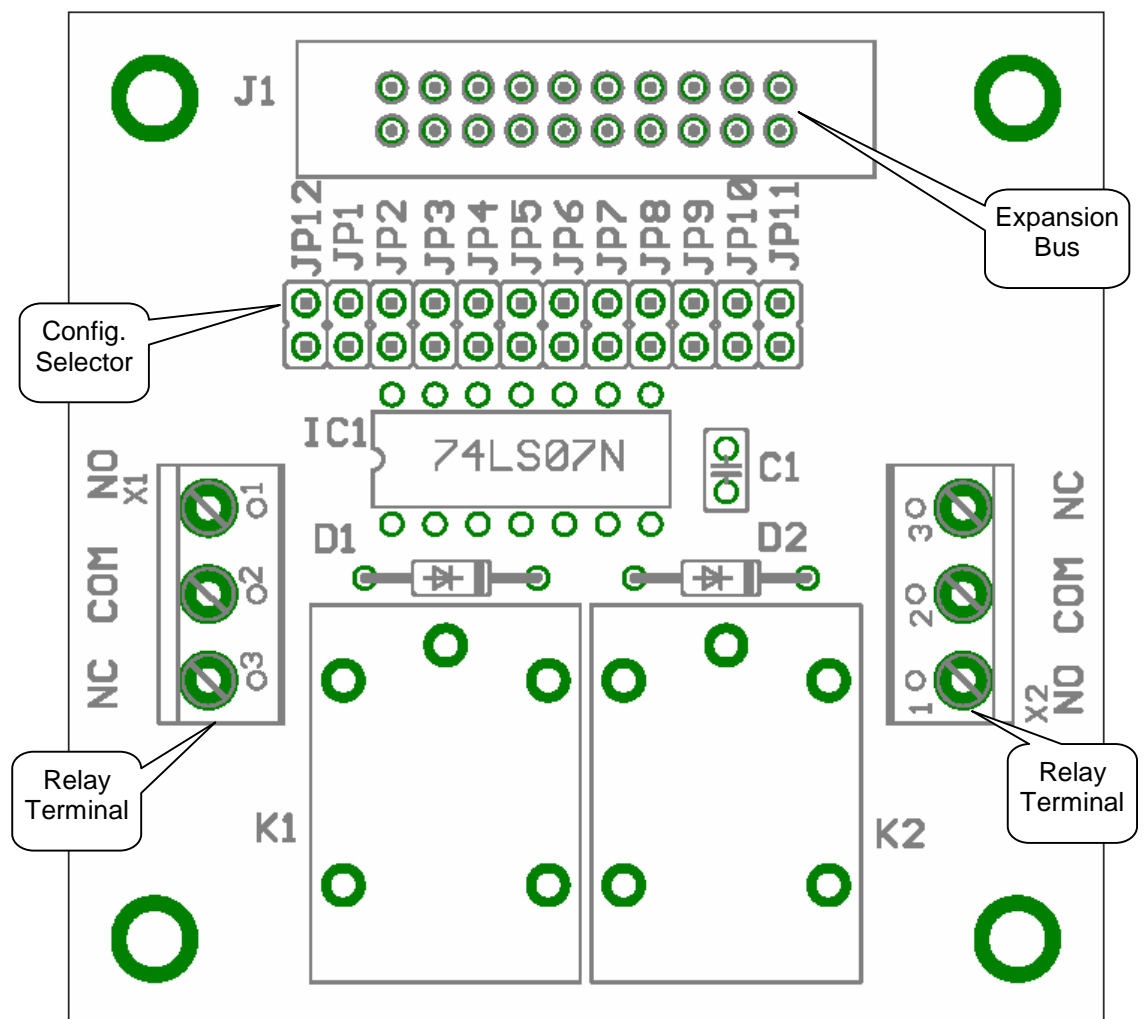

Figure 1

6. Schematics

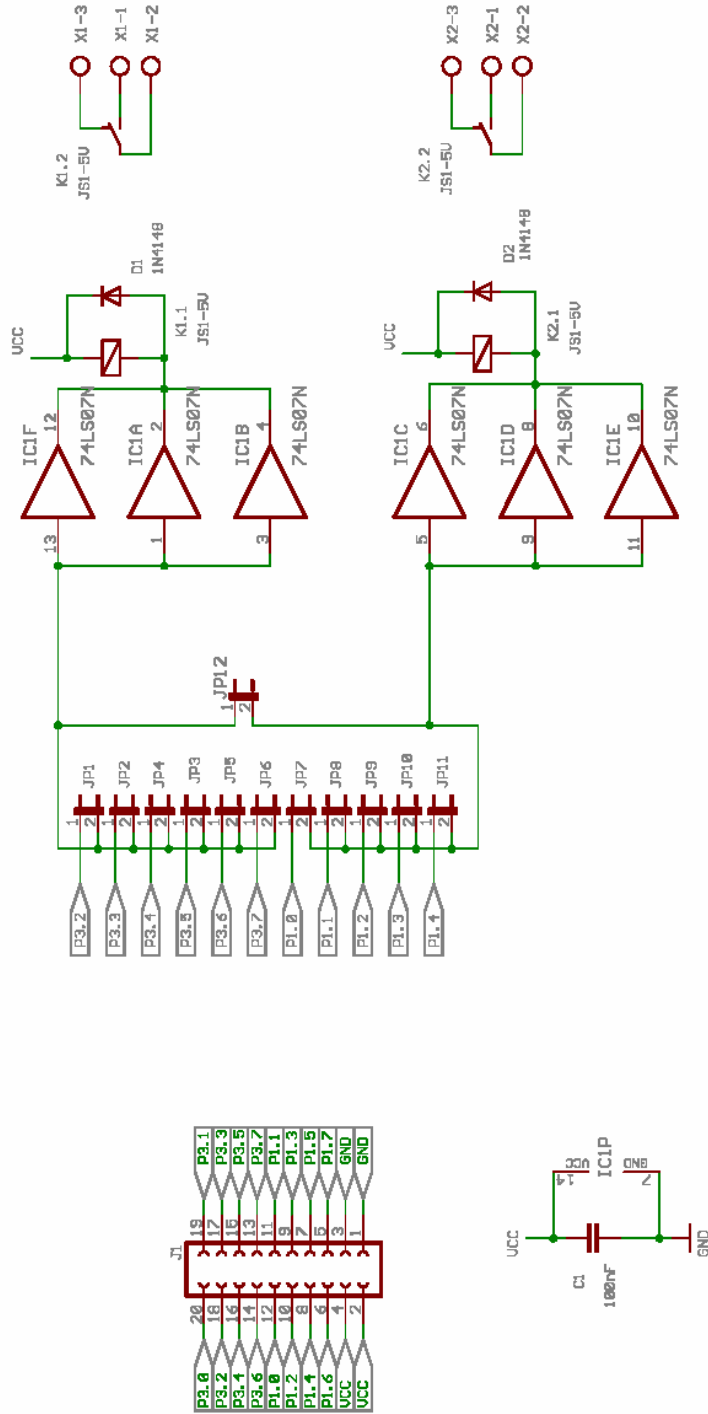

Figure 2

BiPOM Electronics

TITLE: 2RELAY

Document Number:

REV:
1.01

Date: 09.01.2003 11:28:38

Sheet: 1/1