

RLY104 Schematic

(This schematic accurately represents the circuit, but some individual components are combined in a single package on the product PCB)

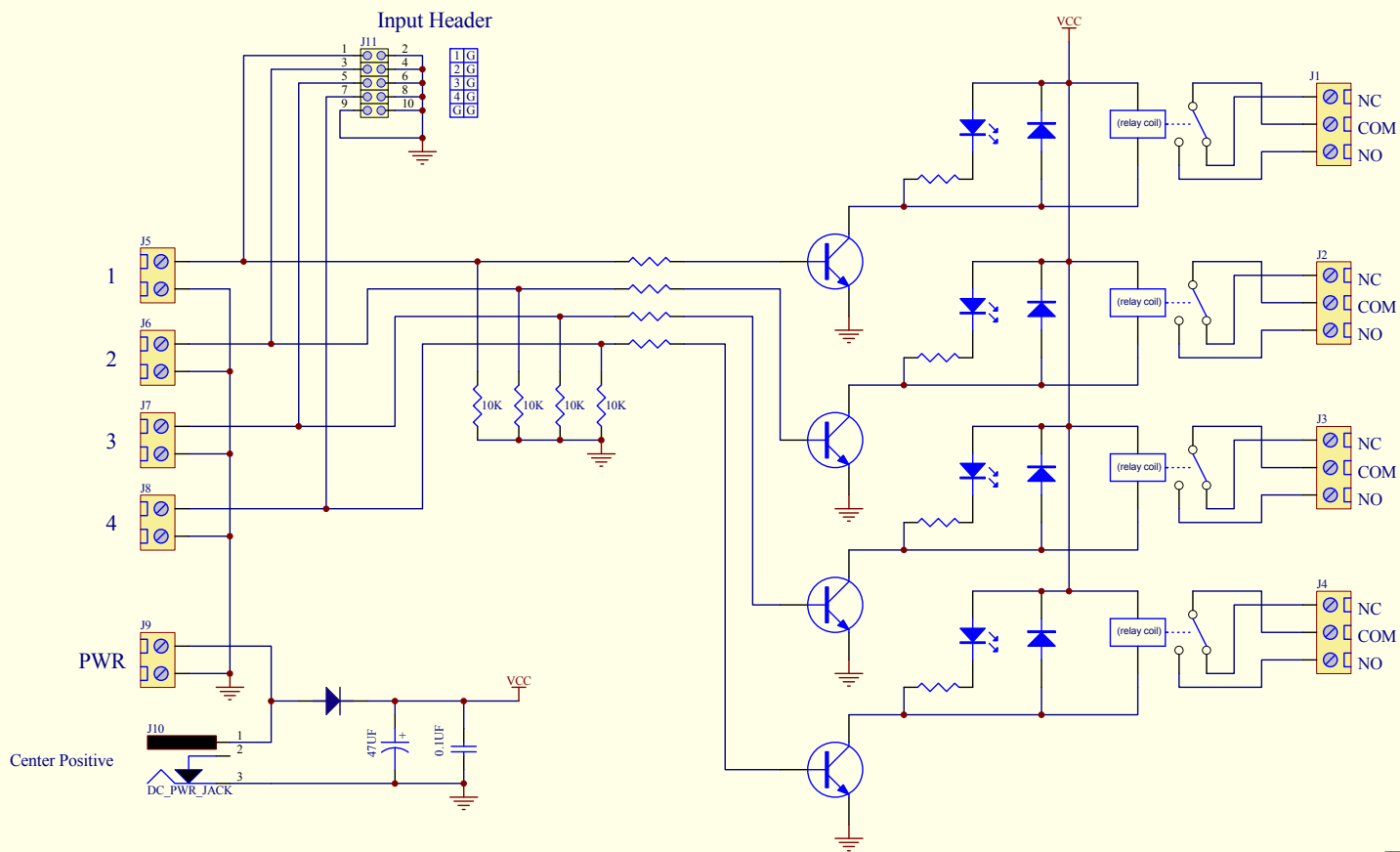

RLY104
4-RELAY BOARD
WINFORD ENGINEERING
www.winford.com