



LK202-25 / VK202-25

Including LK202-25-USB and VK202-25-USB

Technical Manual

Revision 4.0

PCB Revision: 3.0 or Higher (Standard Model), 1.0 or Higher (USB Model)

Firmware Revision: 5.6 or Higher

Revision History

Revision	Date	Description	Author
4.0	August 2, 2012	Initial Release	Clark

Contents

1 Introduction	1
2 Quick Connect Guide.....	2
2.1 Available Headers	2
2.2 Standard Module	3
Recommended Parts.....	3
Serial Connections.....	3
I ² C Connections	4
2.3 USB Module	5
Recommended Parts.....	5
USB Connections.....	5
3 Software	6
3.1 uProject.....	6
3.2 Application Notes.....	7
4 Hardware.....	8
4.1 Standard Model	8
Communication/Power Header	8
Serial DB9 Connector	8
Power Through DB9 Jumper	9
Protocol Select Jumpers.....	9
4.2 USB Model.....	10
Mini USB Connector.....	10
Alternate USB Header	10
Alternate Power Connector	10
4.3 Common Features.....	11
General Purpose Outputs	11
Dallas One-Wire Connector	11
Keypad Header.....	12
5 Troubleshooting.....	13
5.1 Power	13
5.2 Display.....	13

5.3 Communication.....	14
5.4 Manual Override	14
6 Commands	15
6.1 Communication.....	15
6.2 Text.....	16
6.3 Special Characters.....	18
6.4 General Purpose Output	20
6.5 Dallas One-Wire	21
6.6 Keypad.....	22
6.7 Display Functions	23
6.8 Data Security.....	25
6.9 Miscellaneous	26
7 Appendix	27
7.1 Command Summary	27
7.2 Character Sets	30
7.3 Block Diagram	32
7.4 Environmental Specifications.....	32
7.5 Electrical Tolerances	32
7.6 Dimensional Drawings	33
7.7 Optical Characteristics	35
8 Ordering	35
8.1 Part Numbering Scheme	35
8.2 Options.....	35
8.3 Accessories.....	36
9 Definitions.....	38
10 Contact.....	38

1 Introduction

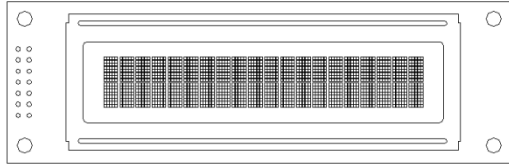

Figure 1: LK202-25 Display

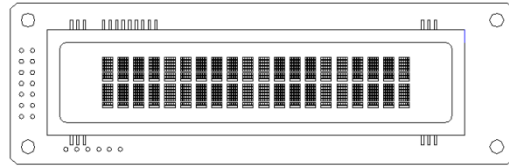

Figure 2: VK202-25 Display

The LK202-25/VK202-25 is an intelligent alphanumeric liquid crystal display designed to decrease development time by providing an instant solution to any project. In addition to the RS232, TTL and I2C protocols available in the standard model, a USB communication model allow the LK202-25/VK202-25 to be connected to a wide variety of host controllers. Communication speeds of up to 115.2kbps for serial protocols and 100kbps for I²C ensure lightning fast display updates.

The simple command structure permits easy software control of many settings including backlight brightness, screen contrast, and baud rate. On board memory provides up to forty custom characters which can be saved within the unit and recalled for start screens, bar graphs or larger numbers.

User input on the LK202-25/VK202-25 is available through a five by five matrix style keypad, and six general purpose outputs provide simple switchable five volt sources. In addition, the option of a Dallas One-Wire header provides a communication interface for up to thirty-two devices.

The versatile LK202-25/VK202-25, with all the features mentioned above, is available in a variety of colour, voltage, and temperature options to suit almost any application.

2 Quick Connect Guide

2.1 Available Headers

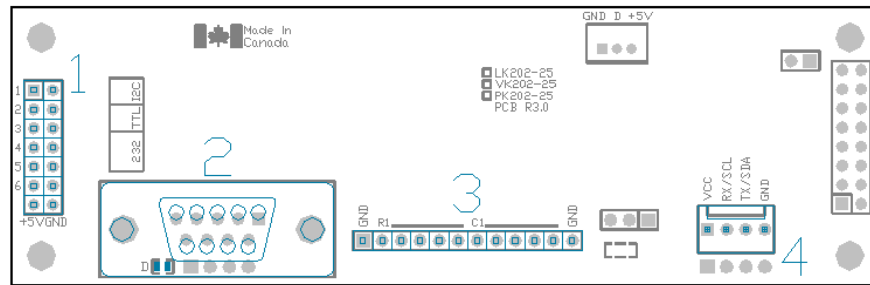

Figure 3: LK202-25/VK202-25 Standard Module Header Locations

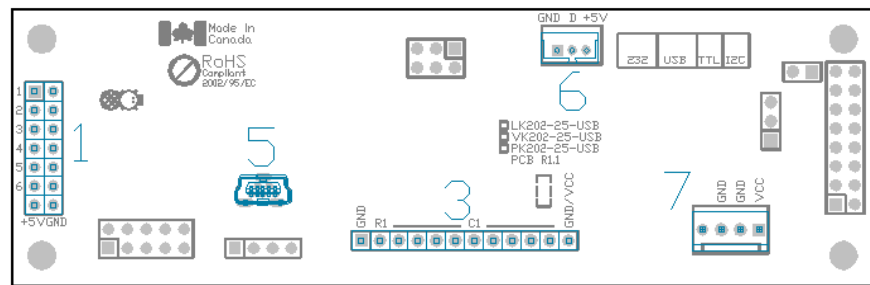

Figure 4: LK202-25/VK202-25 USB Model Header Locations

Table 1: List of Available Headers

#	Header	Mate	Population
1	GPO Header	None Offered	All Models
2	DB9 Serial Header	CSS1FT/CSS4FT	Standard Model Only
3	Keypad	KPP4x4	All Models
4	Communication/Power Connector	SCCPC5V/BBC	Standard Model Only
5	Mini USB Connector	EXTMUSB3FT/INTMUSB3FT	USB Model Only
6	Dallas One-Wire Header	Temperature Probe	USB Model Only
7	Alternate Power Connector	PCS	USB Model Only

2.2 Standard Module

The standard version of the LK202-25/VK202-25 allows for user configuration of three common communication protocols. First, the unit can communicate using serial protocol at either RS232 or TTL voltage levels. Second, it can communicate using the Inter-Integrated Circuit connect, or I²C protocol. Connections for each protocol can be accessed through the four pin Communication/Power Header as outlined in the Serial Connections and I²C Connections sections below.

Recommended Parts



Figure 5: Communication/Power Cable (SCCPC5V)

The most common cable choice for any alphanumeric Matrix Orbital Display, the Communication/ Power Cable offers a simple connection to the unit with familiar interfaces. DB9 and floppy power headers provide all necessary input to drive your display.



Figure 6: Breadboard Cable (BBC)

For a more flexible interface to the LK202-25/VK202-25 a Breadboard Cable may be used. This provides a simple four wire connection that is popular among developers for its ease of use in a breadboard environment.

Serial Connections

A serial interface provides a classic connection to the LK202-25/VK202-25. The Communication/Power Cable is most commonly used for this set up as it provides connections for DB9 serial and floppy power cables. To place your board in Serial mode, adhere to the steps laid out below.

1. Set the Protocol Select jumpers.
 - RS232: Connect the three jumpers* in the 232 protocol box with the zero ohm jumper resistors provided or an alternate wire or solder solution.
 - TTL: Connect the two jumpers* in the TTL protocol box.

***Note:** Jumpers must be removed from all protocol boxes save for the one in use.

2. Make the connections.
 - a. Connect the four pin female header of the Communication/Power Cable to the Communication/Power Header of your LK202-25/VK202-25.
 - b. Insert the male end of your serial cable to the corresponding DB9 header of the Communication/Power Cable and the mate the female connector with the desired communication port of your computer.
 - c. Select an unmodified floppy cable from a PC power supply and connect it to the power header of the Communication/Power Cable.
3. Create.
 - Use uProject or a terminal program to get started, and then move on with your own development. A number of application notes are available at www.matrixorbital.ca/appnotes.

I²C Connections

A more advanced connection to the LK202-25/VK202-25 is provided by the I²C protocol setting. This is best accomplished using a breadboard and the Breadboard Cable. Power must be supplied from your breadboard or another external source. To dive right into your application and use the LK202-25/VK202-25 in I²C mode, get started with the guidelines below.

1. Set the Protocol Select switches.
 - I²C: Ensure that the two I²C jumpers in the corresponding protocol box are connected while all others are open.
2. Make the connections.
 - a. Connect the Breadboard Cable to the Communication/Power Header on your LK202-25/VK202-25 and plug the four leads into your breadboard. The red lead will require power, while the black should be connected to ground, and the green and yellow should be connected to your controller clock and data lines respectively.
 - b. Pull up the clock and data lines to five volts using a resistance between one and ten kilohms on your breadboard.
3. Create.
 - This time you're on your own. While there are many examples within the Matrix Orbital AppNote section, www.matrixorbital.ca/appnotes, too many controllers and languages exist to cover them all. If you get stuck in development, it is possible to switch over to another protocol on the standard board, and fellow developers are always on our forums for additional support.

2.3 USB Module

The LK202-25/VK202-25-USB offers a single USB protocol for an easy connection to a host computer. This simple and widely available protocol can be accessed using the on board mini B style USB connector as outlined in the USB Connections section.

Recommended Parts



Figure 7: External Mini USB Cable (EXTMUSB3FT)

The External Mini USB cable is recommended for the LK202-25/VK202-25-USB display. It will connect to the miniB style header on the unit and provide a connection to a regular A style USB connector, commonly found on a PC.

USB Connections

The USB connection is the quickest, easiest solution for PC development. After driver installation, the LK202-25/VK202-25-USB will be accessible through a virtual serial port, providing the same result as a serial setup without the cable hassle. To connect to your LK202-25/VK202-25-USB please follow the steps below.

1. Set the Protocol Select jumpers.
 - USB: The LK202-25/VK202-25-USB offers USB protocol only. Model specific hardware prevents this unit from operating in any other protocol, and does not allow other models to operate in USB. Protocol Select jumpers on the USB model cannot be moved.
2. Make the connections.
 - Plug the mini-B header of your External Mini USB cable into your LK202-25/VK202-25-USB and the regular USB header into your computer USB jack.
3. Install the drivers.
 - a. Download the latest drivers at www.matrixorbital.ca/drivers, and save them to a known location.
 - b. When prompted, install the USB bus controller driver automatically
 - c. If asked, continue anyway, even though the driver is not signed
 - d. When the driver install is complete, your display will turn on, but communication will not yet be possible.
 - e. At the second driver prompt, install the serial port driver automatically
 - f. Again, if asked, continue anyway
4. Create.
 - Use uProject or a terminal program to get started, and then move on with your own development. A number of application notes are available at www.matrixorbital.ca/apnotes.

3 Software

The multiple communication protocols available and simple command structure of the LK202-25/VK202-25 means that a variety of applications can be used to communicate with the display. Text is sent to the display as a character string, for example, sending the decimal value 41 will result in an 'A' appearing on the screen. A number of control characters are also activated. Commands are merely values prefixed with a special command byte, 254 in decimal.

Table 2: Reserved Control Characters

Control Characters							
8	Backspace	10	Line feed / New line	12	Clear screen / New page	13	Carriage return

Once the correct communication port is identified, the following communication settings can be applied to communicate correctly with the LK202-25/VK202-25.

Table 3: Communication Settings

BPS	Data Bits	Parity	Stop Bits	Flow Control
19200	8	None	1	None

Finally, with a communication port identified and correctly setup simple text strings or even command bytes can easily be transmitted to control your display.

3.1 uProject

The Matrix Orbital alphanumeric display tuner, or uProject, is offered as a free download from the www.matrixorbital.ca support site. It allows the basic functionality of *any display to be tested using a simple graphical user interface system.

While basic functionality can be tested using the GUI portion of the program, more advanced users will enjoy the scripting capability found in the uploader tab. Here commands can be stacked, run, and saved for later use. Although many commands are available to be dragged into the script dialog, perhaps the most powerful is the raw data command found in the other branch.

***Note:** The uProject AutoDetect function will not perform correctly when a USB display is connected. Please manually configure any USB display.

This command allows raw bytes to be sent to the display, permitting many different formats for entry and displaying in decimal notation. Any command from this manual may be entered in decimal notation separated by slashes.

/254/ /88/

Figure 8: uProject Command

Again, the clear screen command is sent to a connected display, this time using uProject raw data command style. Scripts can be run as a whole using the execute command from the script menu, or as single commands by selecting execute once. Before issuing commands, it is a good idea to ensure communication with a display is successful using some of the more basic GUI functions in the main window.

This program provides scratch pad upon which a tome of display projects and ideas can be assembled.

3.2 Application Notes

Full demonstration programs and code are available for Matrix Orbital Displays in the C# language from Simple C# AppNote Pack in the Application Note section at www.matrixorbital.ca/appnotes. Difficulty increases from beginner, with the Hello World program, to advanced with the Dallas One-Wire temperature reading application.

Many additional applications are available in a number of different programming languages. These programs are meant to showcase the capability of the display and are not intended to be integrated into a final design. For additional information regarding code, please read the On Code document also found on the support site.

4 Hardware

4.1 Standard Model

Communication/Power Header

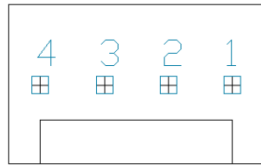

Figure 9: Communication/Power Header

Table 4: Communication/Power Pinout

Pin	Function
1	Vcc
2	Rx (SCL)
3	Tx (SDA)
4	Gnd

The Communication/Power Header provides a standard connector for interfacing to the LK202-25/VK202-25. Voltage is applied through pins one and four of the four pin Communication/Power Header. Please ensure the correct voltage input for your display by referencing Voltage Specifications before connecting power. Pins two and three are reserved for serial transmission, using either the RS-232/TTL or clocking data through the I²C protocol, depending on what has been selected by the Protocol Select Jumpers. The versatile Tyco 640456-4-LF style header used can be mated to a number of connectors, the Molex 22-01-3047 for example.

Serial DB9 Connector

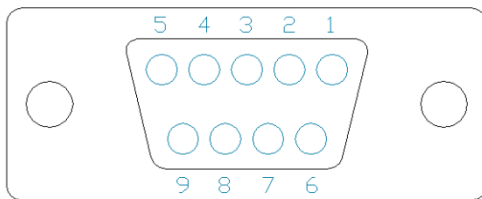

Figure 10: Serial DB9 Connector

Table 5: Serial DB9 Pinout

Pin	Function
2	Tx
3	Rx
5	Gnd
9	NC/Vcc*

The LK202-25/VK202-25 provides a DB-9 Connector to readily interface with serial devices using EIA232 standard signal levels. It is also possible to communicate at TTL levels of 0 to +5V by setting the Protocol Select Jumpers to TTL. As an added feature it is also possible to apply power through pin 9 of the DB-9 Connector in order to reduce cable clutter. A standard male DB9 header will provide the perfect mate for this connector.

***Note:** Do not apply voltage through pin 9 of the DB-9 Connector AND through the Communication/Power Header at the same time.

Power Through DB9 Jumper

In order to provide power through pin 9 of the DB-9 Connector you must connect the Power Through DB-9 Jumper labelled D, as illustrated below. This connection can be made using a zero ohm resistor, recommended size 0603, or a solder bridge. The LK202-25/VK202-25 allows all voltage models to use the power through DB-9 option, see the Voltage Specifications for power requirements.

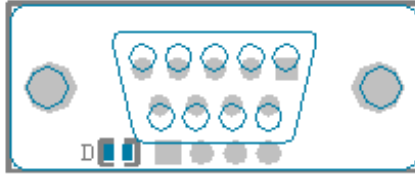

Figure 11: Power Through DB9 Jumper

Protocol Select Jumpers

The Protocol Select Jumpers provide the means necessary to toggle the LK202-25/VK202-25 between RS-232, TTL and I²C protocols. As a default, the jumpers are set to RS-232 mode with solder jumps on the RS232 jumpers. In order to place the display module in I²C mode you must first remove the solder jumps from the RS232 jumpers and then place them on the I²C jumpers. The display will now be in I²C mode and have a default slave address of 80, unless changed with the appropriate command. Similarly, in order to change the display to TTL mode, simply remove the zero ohm resistors from the RS232 or I²C jumpers and solder them to the TTL jumpers.

4.2 USB Model

Mini USB Connector

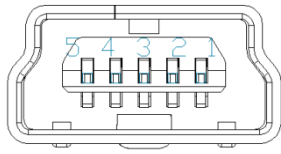

Figure 12: Mini USB Connector

Table 6: Mini USB Pinout

Pin	Function
1	Vcc
2	D-
3	D+
5	Gnd

The LK202-25/VK202-25-USB comes with a familiar Mini USB Connector to fulfill both communication and power needs. The standard MiniB style header can be connected to any other USB style using the appropriate cable. Most commonly used with a PC, this connection creates a virtual com port that offers a simple power solution with a familiar communication scheme.

Alternate USB Header

Some advanced applications may prefer the straight four pin connection offered through the Optional Alternate USB Header. This header offers power and communication access in a simple interface package. The Optional Alternate USB Header may be added to the LK202-25/VK202-25-USB for an added charge as part of a custom order. Please use the Contact section to request more information from the friendly Matrix Orbital sales team.

Alternate Power Connector

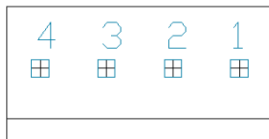

Figure 13: Alternate Power Connector

Table 7: Alternate Power Pinout

Pin	Function
1	Vcc
2	Gnd
3	Gnd
4	NC

The Alternate Power Connector provides the ability to power the LK202-25/VK202-25-USB using a second cable. The Tyco 171825-4 style header is particularly useful for connecting to an unmodified floppy power cable, a 171822-4 for example, from a PC power supply for a simple bench power solution.

4.3 Common Features

General Purpose Outputs

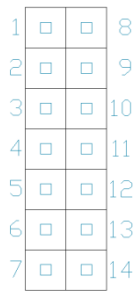

Figure 14: GPO Header

Table 8: GPO Pinout

Pin	Function	Pin	Function
1	GPO 1	8	Gnd
2	GPO 2	9	Gnd
3	GPO 3	10	Gnd
4	GPO 4	11	Gnd
5	GPO 5	12	Gnd
6	GPO 6	13	Gnd
7	Vcc	14	Gnd

A unique feature of the LK202-25/VK202-25 is the ability to control relays* and other external devices using either one or six General Purpose Outputs. Each can source up to 10mA of current at five volts when on or sink 20mA at zero volts when off. The two row, fourteen pin header can be interfaced to a number of female connectors to provide control to any peripheral devices required.

***Note:** If connecting a relay, be sure that it is fully clamped using a diode and capacitor in order to absorb any electro-motive force (EMF) which will be generated.

Dallas One-Wire Connector

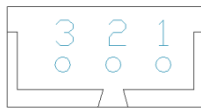

Figure 15: Dallas One-Wire Connector

Table 9: Dallas One-Wire Pinout

Pin	Function
1	Vcc
2	D
3	Gnd

In addition to the six general purpose outputs the LK202-25/VK202-25 offers an Optional Dallas One-Wire bridge, to allow for an additional thirty two one-wire devices to be connected to the display. This header can be populated with a Tyco 173979 connector at an added cost by custom order only. Please use the Contact section to request more information from the Matrix Orbital sales team.

Keypad Header



Figure 16: Keypad Header

Table 10: Keypad Pinout

Pin	Function	Pin	Function
1	Gnd	7	Column 1
2	Row 1	8	Column 2
3	Row 2	9	Column 3
4	Row 3	10	Column 4
5	Row 4	11	Column 5
6	Row 5	12	Gnd/Vcc*

To facilitate user input, the LK202-25/VK202-25 provides a Keypad Interface Connector which allows a matrix style keypad of up to twenty-five keys to be directly connected to the display module. Key presses are generated when a short is detected between a row and a column. When a key press is generated, a character specific to that key press is automatically sent on the Tx communication line. If the display module is running in I²C mode, the “Auto Transmit Keypress” function may be turned off to allow the key presses to remain in the buffer so that they may be polled. The character that is associated with each key press may also be altered using the “Assign Key Codes” command. The straight twelve pin header of the Keypad Interface Connector will interface to a variety of different devices including the Matrix Orbital KPP4x4 keypad.

***Note:** The Ground / +5V pin is toggled by the jumper to the right of the keypad connector. Jump pads 1 & 2 for +5V or 2 & 3 for GND.

5 Troubleshooting

5.1 Power

In order for your LK202-25/VK202-25 to function correctly, it must be supplied with the appropriate power. If the screen is not illuminated, power may not be applied correctly. Try the tips below.

- First, make sure that you are using the correct power connector. Standard floppy drive power cables from your PC power supply may fit on the Communication/Power Header; however they do not have the correct pin out to provide power. Matrix Orbital supplies power cable adapters for connecting to a PC, which can be found in the Accessories section.
- Next, check the power cable which you are using for continuity. If you don't have an ohm meter, try using a different power cable, if this does not help try using a different power supply.
- If power is applied through the DB9 connector, ensure that the Power Through DB9 Jumper is connected.
- If changes have been made to the protocol select block, ensure all the appropriate protocol select jumpers are connected and all unused protocol jumpers are disconnected.
- The last step will be to check the interface connector in use on your display. If the power connections have become loose, or you are unable to resolve the issue, please Contact Matrix Orbital for more information.

5.2 Display

If your display is powered successfully, the Matrix Orbital logo, or user created screen should display on start up. If this is not the case, check out these tips.

- Ensure the contrast is not too high or too low. This can result in a darkened or blank screen respectively. See the Manual Override section to reset to default.
- Make sure that the start screen is not blank. It is possible to overwrite the Matrix Orbital logo start screen, if this happens the screen may be blank. Try writing to the display to ensure it is functional, after checking the contrast above.

5.3 Communication

When communication of either text or commands is interrupted, try the steps below.

- First, check the communication cable for continuity. If you don't have an ohm meter, try using a different communication cable. If you are using a PC try using a different Com/USB Port.
- Next, please ensure that the display module is set to communicate on the protocol that you are using, by checking the Protocol Select Jumpers.
- In serial and USB protocols, ensure that the host system and display module are both communicating on the same baud rate. The default rate for the display module is 19200 bps.
- Match Rx from your display to the transmitting pin from your host and the Tx pin to the receiving pin.
- If you are communicating to the display via I²C* please ensure that the data is being sent to the correct address. The default slave address for the display module is 80.
- In I²C mode, connect Rx to the clock line of your controller and Tx to the data output.
- Unlock the display. See the Set and Save Data Lock command for more info.
- Finally, you may reset the display to its default settings using the Manual Override procedure outlined below.

***Note:** I²C communication will always require pull up resistors on SCL and SDA of one to ten kilohms.

5.4 Manual Override

Should the settings of your display become altered in a way that dramatically impacts usability, the default settings can be temporarily restored. To override the display, please follow the steps below.

1. Disconnect power from your display.
2. Place a jumper on the middle two keypad pins, R5 and C1.
3. Reconnect power to your unit, and wait for the start screen before removing the jumper.
4. Settings will be temporarily** overridden to the defaults listed in the Manual Override Settings table. At this point any important settings, such as contrast, backlight, or baud rate, should not only be set but saved so they remain when the override is removed.

Parameter	Value
Backlight	255
Contrast	128
Baud Rate	19200
I ² C Address	80

Table 11: Manual Override Settings

****Note:** The display module will revert back to the old settings once turned off, unless desired settings are saved.

6 Commands

6.1 Communication

1.1 Change Baud Rate	Dec	254 57	Speed	v5.6
	Hex	FE 39	Speed	
	ASCII	■ 9	Speed	
Immediately changes the baud rate. Not available in I2C. Baud rate can be temporarily forced to 19200 by a manual override.				
Speed	Byte	Valid settings shown below.		

Table 12: Accepted Baud Rate Values

Rate	1200	2400	4800	9600	19200	28800	38400	57600	*76800	*115200
Speed	83	41	207	103	51	34	25	16	12	8

***Note:** Baud rates 76800 and 115200 added with the release of firmware revision 5.7 as per PCN 2006-08-24.

1.2 Change I²C Slave Address	Dec	254 51	Address	v5.6
	Hex	FE 33	Address	
	ASCII	■ 3	Address	
Immediately changes the I ² C write address. Only even values are permitted as the next odd address will become the read address. Default is 80.				
Address	Byte	Even value.		

1.3 Transmission Protocol Select	Dec	254 160	Protocol	v5.6
	Hex	FE A0	Protocol	
	ASCII	■ á	Protocol	
Selects the protocol used for data transmission from the display. Data transmission to the display is not affected. Must be set to the protocol in use to receive data correctly.				
Protocol	Byte	1 for Serial (RS232/RS422/TTL/USB) or 0 for I ² C.		

1.4 Set a Non-Standard Baud Rate	Dec	254 164	Speed	v5.6
	Hex	FE A4	Speed	
	ASCII	■ ñ	Speed	
Immediately changes the baud rate to a non-standard value. Speed must be a whole number between 977 and 153800. Due to rounding, error increases with baud rate, actual baud must be within 3% of desired baud to ensure accurate communication. Not available in I2C. Can be temporarily forced to 19200 by a manual override.				
Speed	Word	Calculations shown below, standard crystal speed is 16MHz.		

$$Speed = \frac{CrystalSpeed}{(8 \times DesiredBaud)} - 1 \quad ActualBaud = \frac{CrystalSpeed}{(8 \times (Speed + 1))}$$

Equation 1: Speed Byte Calculation *Equation 2: Actual Baud Rate Calculation*

$$\frac{|DesiredBaud - ActualBaud|}{DesiredBaud} < 0.03$$

Equation 3: Baud Rate Error Calculation

6.2 Text

2.1 Clear Screen	Dec	254 88		v5.6
	Hex	FE 58		
	ASCII	■ X		

Clears the contents of the screen.

2.2 Change the Start Up Screen	Dec	254 64	Characters	v5.6
	Hex	FE 40	Characters	
	ASCII	■ @	Characters	

Changes the message displayed on start up. Custom characters can be included by adding their decimal value (0-7). Characters will automatically wrap on the display.

Characters 80 bytes, space characters can be added as needed

2.3 Auto Scroll On	Dec	254 81		v5.6
	Hex	FE 51		
	ASCII	■ Q		

The entire contents of screen are shifted up one line when the end of the screen is reached. Display default is on.

2.4 Auto Scroll Off	Dec	254 82		v5.6
	Hex	FE 52		
	ASCII	■ R		

New text is written over the top line when the end of the screen is reached. Display default is Auto Scroll on.

2.5 Set Auto Line Wrap On	Dec	254 67		v5.6
	Hex	FE 43		
	ASCII	■ C		

Text will wrap to the next consecutive line once a row becomes full. Default is Auto Line Wrap on.

2.6 Set Auto Line Wrap Off	Dec	254 68		v5.6
	Hex	FE 44		
	ASCII	■ D		

Text will skip one line when wrapping once a row becomes full. Writing order will be rows 1, 3, 2, and then 4. Default is Auto Line Wrap on.

2.7 Set Cursor Position	Dec	254 71	Column Row	v5.6
	Hex	FE 47	Column Row	
	ASCII	■ G	Column Row	

Sets the cursor to a specific cursor position where the next transmitted character is printed.

Column **Byte** Value between 1 and number of character columns.

Row **Byte** Value between 1 and number of character rows.

2.8 Go Home	Dec	254 72	v5.6
	Hex	FE 48	
	ASCII	■ H	
Returns the cursor to the top left of the screen.			

2.9 Move Cursor Back	Dec	254 76	v5.6
	Hex	FE 4C	
	ASCII	■ L	
Moves cursor one position to the left. Cursor will obey wrap settings.			

2.10 Move Cursor Forward	Dec	254 77	v5.6
	Hex	FE 4D	
	ASCII	■ M	
Moves cursor one position to the right. Cursor will obey wrap settings.			

2.11 Underline Cursor On	Dec	254 74	v5.6
	Hex	FE 4A	
	ASCII	■ J	
Displays a line under the current cursor position. Can be used with block cursor.			

2.12 Underline Cursor Off	Dec	254 75	v5.6
	Hex	FE 4B	
	ASCII	■ K	
Removes line under current cursor position.			

2.13 Blinking Block Cursor On	Dec	254 83	v5.6
	Hex	FE 53	
	ASCII	■ S	
Displays a blinking block over the current cursor position. Can be used with underline.			

2.14 Blinking Block Cursor Off	Dec	254 84	v5.6
	Hex	FE 54	
	ASCII	■ T	
Removes blinking block over current cursor position.			

6.3 Special Characters

3.1 Create a Custom Character	Dec	254 78	ID Data	v5.6
	Hex	FE 4E	ID Data	
	ASCII	■ N	ID Data	
Creates a custom character. Each character is divided into 8 rows of 5 pixels; each data byte represents one row. Each byte is padded by three zero bits followed by five bits representing each pixel state. A one represents an on condition while a zero is off. Characters are lost when a new memory bank is loaded, unless they are saved.				
ID	Byte	Character ID, value between 0 and 7.		
Data	Byte[8]	Character pixel data as shown below.		

Table 13: Custom Degree Character

Data[1]	000	p1	p2	p3	p4	p5	00001000	8
Data[2]	000	p1	p2	p3	p4	p5	00010100	20
Data[3]	000	p1	p2	p3	p4	p5	00001000	8
Data[4]	000	p1	p2	p3	p4	p5	00000011	3
Data[5]	000	p1	p2	p3	p4	p5	00000100	4
Data[6]	000	p1	p2	p3	p4	p5	00000100	4
Data[7]	000	p1	p2	p3	p4	p5	00000011	3
Data[8]	000	p1	p2	p3	p4	p5	00000000	0

3.2 Save Custom Characters	Dec	254 193	Bank ID Data	v5.6
	Hex	FE C1	Bank ID Data	
	ASCII	■ ñ	Bank ID Data	
Provides access to all memory banks to create and save custom characters, graph bars, and large digits. Any new characters saved will overwrite the old, so care should be taken when writing to any bar or digit memory bank. Bank structure is shown below.				
Bank	Byte	1 byte, memory bank ID, value between 0 and 4, as below.		
ID	Byte	1 byte, value between 0 and 7.		
Data	Byte[8]	8 bytes, character pixel data as above.		

Table 14: Custom Character Banks

0	Start-up Characters	1	Horizontal Bars	2	Vertical Bars	3	Medium Digits	4	Large Digits
----------	---------------------	----------	-----------------	----------	---------------	----------	---------------	----------	--------------

3.3 Load Custom Characters	Dec	254 192	Bank	v5.6
	Hex	FE C0	Bank	
	ASCII	■ L	Bank	
Loads a bank of custom characters into memory for use. Must be issued before using a bank of characters. Alternatively, an appropriate initialize command can be used.				
Bank	Byte	Memory bank ID, value between 0 and 4, as above.		

3.4 Save Start Up Screen Custom Characters	Dec	254 194	ID Data	v5.6
	Hex	FE C2	ID Data	
	ASCII	■ T	ID Data	
Saves a custom character to memory for the start up screen or repeated use. Start up characters are displayed by sending their ID to the screen.				
ID	Byte	Value between 0 and 7.		
Data	Byte[8]	Character pixel data, see Custom Degree Character example.		

3.5 Initialize Medium Numbers	Dec	254 109		v5.6
	Hex	FE 6D		
	ASCII	■ m		
Loads the medium number custom character bank into memory. Medium numbers must be initialized before use.				

3.6 Place Medium Numbers	Dec	254 111	Row Column Digit	v5.6
	Hex	FE 6F	Row Column Digit	
	ASCII	■ o	Row Column Digit	
Places a single medium decimal digit of 2 row height and 1 column width on the display at the position specified. Medium numbers must be initialized before being placed.				
Row	Byte	Value between 1 and 20.		
Column	Byte	Value between 1 and 4.		
Digit	Byte	Single decimal digit to display.		

3.7 Initialize Horizontal Bar	Dec	254 104		v5.6
	Hex	FE 68		
	ASCII	■ h		
Loads the horizontal bar graph custom character bank into memory. Horizontal bar characters must be initialized before a graph is displayed.				

3.8 Place Horizontal Bar Graph	Dec	254 124	Column Row Direction Length	v5.6
	Hex	FE 7C	Column Row Direction Length	
	ASCII	■ 	Column Row Direction Length	
Places a horizontal bar graph on the screen beginning at the column and row specified. The bar extends either right or left to the length indicated. New bars will overwrite old.				
Column	Byte	1 byte, value between 1 and 20		
Row	Byte	1 byte, value between 1 and 4		
Direction	Byte	1 byte, 0 for right and 1 for left		
Length	Byte	1 byte, length in pixels of the graph, value between 0 and 100		

3.9 Initialize Narrow Vertical Bar	Dec	254 115		v5.6
	Hex	FE 73		
	ASCII	■ s		
Loads the narrow horizontal bar graph custom character bank into memory. A narrow bar is 2 pixels wide. Horizontal bar characters must be initialized before a graph is displayed.				

3.10 Initialize Wide Vertical Bar	Dec	254 118		v5.6
	Hex	FE 76		
	ASCII	■ v		

Loads the wide horizontal bar graph custom character bank into memory. A wide bar is 5 pixels wide. Horizontal bar characters must be initialized before a graph is displayed.

3.11 Place Vertical Bar	Dec	254 61	Column Length	v5.6
	Hex	FE 3D	Column Length	
	ASCII	■ =	Column Length	

Places a vertical bar graph on the screen extending from the first row of the column specified. The bar extends upwards to the length indicated. A new bar will over write the old.

Column	Byte	Value between 1 and 20.
Length	Byte	Height in pixels of the graph, value between 0 and 32.

6.4 General Purpose Output

4.1 General Purpose Output On	Dec	254 87	Number	v5.6
	Hex	FE 57	Number	
	ASCII	■ W	Number	

Turns the specified GPO on, sourcing current from an output of five volts.

Number	Byte	GPO to be turned on.
---------------	-------------	----------------------

4.2 General Purpose Output Off	Dec	254 86	Number	v5.6
	Hex	FE 56	Number	
	ASCII	■ V	Number	

Turns the specified GPO off, sinking current to an output of zero volts.

Number	Byte	GPO to be turned off.
---------------	-------------	-----------------------

4.3 Set Start Up GPO State	Dec	254 195	Number State	v5.6
	Hex	FE C3	Number State	
	ASCII	■ 	Number State	

Sets and saves the start up state of the specified GPO in non volatile memory. Changes will be seen on start up.

Number	Byte	GPO to be controlled.
State	Byte	1 for on or 0 for off.

6.5 Dallas One-Wire

5.1 Search for a One-Wire Device	Dec	254 200 2	v5.6
	Hex	FE C8 02	
	ASCII	■ ℒ SOT	
Sends a search query to each of the up to 32 devices on the one wire bus. Any connected device will respond with an identification packet.			
Response	Bytes [14]	Dallas One-Wire identification packet as shown below.	

Table 15: Dallas One-Wire Packet Information

Offset	Length	Value	Description
0	2	9002	Preamble
2	1	138	Another device packet will follow OR
		10	Last device packet
3	1	49	Packet Type
4	1	0	Error Code (0 indicates success)
5	8		Device Address
13	1	0	CRC8 address check (0 indicates validity)

5.2 Dallas One-Wire Transaction	Dec	254 200 1	Flags	Send Bits	Receive Bits	Data	v5.6
	Hex	FE C8 01	Flags	Send Bits	Receive Bits	Data	
	ASCII	■ ℒ STX	Flags	Send Bits	Receive Bits	Data	
Performs a single Dallas 1-Wire transaction. Consult your device documentation for information regarding device specific protocols. If an error is encountered, a corresponding value will be returned by the device.							
Flags	Byte	Flags for transaction, see below.					
Send Bits	Byte	Number of bytes to be sent to the device.					
Receive Bits	Byte	Number of bytes expected to be received from the device.					
Data	Byte(s)	Data to be transmitted LSB to MSB.					

Table 16: Dallas One-Wire Flags

Bit	Flag Description
7	
6	Unused
5	
4	0 (Future Compatibility)
3	Add CRC8 to transaction
2	0 (Future Compatibility)
1	Read CRC8 from transaction
0	Reset Bus prior to transaction

Table 17: Dallas One-Wire Errors

Code	Error Description
0	Success
1	Unknown Command
2	No Devices Found
3	Fatal Search Error

6.6 Keypad

6.1 Auto Transmit Key Presses On	Dec	254 65		v5.6
	Hex	FE 41		
	ASCII	■ A		
Key presses are automatically sent to the host when received by the display. Default is Auto Transmit on.				
6.2 Auto Transmit Key Presses Off	Dec	254 79		v5.6
	Hex	FE 4F		
	ASCII	■ O		
Key presses are held in the 10 key buffer to be polled by the host using the Poll Key Press command. Use this mode for I2C transactions. Default is Auto Transmit on.				
6.3 Poll Key Press	Dec	254 38		v5.6
	Hex	FE 26		
	ASCII	■ &		
Reads the last unread key press from the 10 key display buffer. If another key is stored in the buffer the MSB will be 1, the MSB will be 0 when the last key press is read. If there are no stored key presses a value of 0 will be returned. Auto transmit key presses must be turned off for this command to be successful.				
Response	Byte	Value of key pressed (MSb determines additional keys to be read).		
6.4 Clear Key Buffer	Dec	254 69		v5.6
	Hex	FE 45		
	ASCII	■ E		
Clears all key presses from the key buffer.				
6.5 Set Debounce Time	Dec	254 85	Time	v5.6
	Hex	FE 55	Time	
	ASCII	■ U	Time	
Sets the time between a key press and a key read by the display. Most switches will bounce when pressed; the debounce time allows the switch to settle for an accurate read. Default is 8 representing approximately 52ms.				
Time	Byte	Debounce increment (debounce time = Time * 6.554ms).		
6.6 Set Auto Repeat Mode	Dec	254 126	Mode	v5.6
	Hex	FE 7E	Mode	
	ASCII	■ DEL	Mode	
Sets key press repeat mode to typematic or hold. In typematic mode if a key press is held, the key value is transmitted immediately, then 5 times a second after a 1 second delay. In hold mode, the key down value is transmitted once when pressed, and then the key up value is sent when the key is released. Default is typematic.				
Mode	Byte	1 for hold mode or 0 for typematic.		

6.7 Auto Repeat Mode Off	Dec	254 96			v5.6
	Hex	FE 60			
	ASCII	■ `			

Turns auto repeat mode off. Default is on (typematic).

6.8 Assign Keypad Codes	Dec	254 213	Key Down	Key Up	v5.6
	Hex	FE D5	Key Down	Key Up	
	ASCII	■ F	Key Down	Key Up	

Assigns the key down and key up values sent to the host when a key press is detected. A key up and key down value must be sent for every key, a value of 255 will leave the key unaltered. Defaults are shown below.

Key Down	Bytes [25]	Key down values, beginning at row one column one moving right then down.
Key Up	Bytes [25]	Key up values, beginning at row one column one moving right then down.

Table 18: Default Key Down Values

Key Down				
A(65)	B(66)	C(67)	D(68)	E(69)
F(70)	G(71)	H(72)	I(73)	J(74)
K(75)	L(76)	M(77)	N(78)	O(79)
P(80)	Q(81)	R(82)	S(83)	T(84)
U(85)	V(86)	W(87)	X(88)	Y(89)

Table 19: Default Key Up Values

Key Up				
a(97)	b(98)	c(99)	d(100)	e(101)
f(102)	g(103)	h(104)	i(105)	j(106)
k(107)	l(108)	m(109)	n(110)	o(111)
p(112)	q(113)	r(114)	s(115)	t(116)
u(117)	v(118)	w(119)	x(120)	y(121)

6.7 Display Functions

7.1 Backlight On	Dec	254 66	Minutes	v5.6
	Hex	FE 42	Minutes	
	ASCII	■ B	Minutes	

Turns the display backlight on for a specified length of time. If an inverse display color is used this command will essentially turn on the text.

Minutes	Byte	Number of minutes to leave backlight on, a value of 0 leaves the display on indefinitely.
----------------	-------------	---

7.2 Backlight Off	Dec	254 70		v5.6
	Hex	FE 46		
	ASCII	■ F		

Turns the display backlight off. If an inverse display colour is used this command will turn off the text.

7.3 Set Brightness*	Dec	254 153	Brightness	v5.6
	Hex	FE 99	Brightness	
	ASCII	■ Ö	Brightness	
Immediately sets the backlight brightness. If an inverse display color is used this represents the text colour intensity instead. Default is 255.				
Brightness	Byte	Brightness level from 0(Dim) to 255(Bright).		

7.4 Set and Save Brightness*	Dec	254 152	Brightness	v5.6
	Hex	FE 98	Brightness	
	ASCII	■ ÿ	Brightness	
Immediately sets and saves the backlight brightness. Although brightness can be changed using the set command, it is reset to this saved value on start up. Default is 255.				
Brightness	Byte	Brightness level from 0(Dim) to 255(Bright).		

7.5 Set Contrast*	Dec	254 80	Contrast	v5.6
	Hex	FE 50	Contrast	
	ASCII	■ P	Contrast	
Immediately sets the contrast between background and text. If an inverse display color is used this also represents the text brightness. Default is 128.				
Contrast	Byte	Contrast level from 0(Light) to 255(Dark).		

7.6 Set and Save Contrast*	Dec	254 145	Contrast	v5.6
	Hex	FE 91	Contrast	
	ASCII	■ æ	Contrast	
Immediately sets and saves the contrast between background and text. Although contrast can be changed using the set command, it is reset to this saved value on start up. Default is 128.				
Contrast	Byte	Contrast level from 0(Light) to 255(Dark).		

7.7 Set VFD Brightness**	Dec	254 89	Brightness	v5.6
	Hex	FE 59	Brightness	
	ASCII	■ Y	Brightness	
Immediately sets the text brightness. Default is 0.				
Brightness	Byte	Brightness level from 3(Dim) to 0(Bright)		

7.8 Set and Save VFD Brightness**	Dec	254 145	Brightness	v5.6
	Hex	FE 91	Brightness	
	ASCII	■ æ	Brightness	
Immediately sets and saves the text brightness. Although brightness can be changed using the set command, it is reset to the saved value on start up. Default is 0.				
Brightness	Byte	Brightness level from 3(Dim) to 0(Bright)		

*Note: LCD Model specific command.

**Note: VFD Model specific command.

6.8 Data Security

8.1 Set Remember	Dec	254 147	Switch	v5.6
	Hex	FE 93	Switch	
	ASCII	■ ô	Switch	
Allows changes to specific settings to be saved to the display memory. Writing to non-volatile memory can be slow and each change consumes 1 write of at least 100,000 available. The Command Summary outlines which commands are saved always, never, and when this command is on only. Remember is off by default.				
Switch	Byte	1 for on or 0 for off.		

8.2 Set Data Lock	Dec	254 202 245 160	Level	v5.6
	Hex	FE CA F5 A0	Level	
	ASCII	■ ¨ á	Level	
Temporarily locks certain aspects of the display to ensure no inadvertent changes are made. The lock is released after a power cycle. A new level overrides the old, and levels can be combined. Default is 0.				
Level	Byte	Lock level, see Data Lock Bits table.		

Table 20: Data Lock Bits

Display	Command	Reserved	Setting	Address	Reserved	Reserved	Reserved
7	6	5	4	3	2	1	0

Table 21: Lock Parameters

Reserved	Place holders only, should be 0
Address	Locks the Baud Rate and I2C address
Setting	Locks all settings from being saved
Command	Locks all commands, text can still be written
Display	Locks entire display, no new text can be displayed

8.3 Set and Save Data Lock	Dec	254 203 245 160	Level	v5.6
	Hex	FE CB F5 A0	Level	
	ASCII	■ ¨ á	Level	
Locks certain aspects of the display to ensure no inadvertent changes are made. The lock is not affected by a power cycle. A new level overrides the old, and levels can be combined. Default is 0.				
Level	Byte	See Data Lock Bits table.		

6.9 Miscellaneous

9.1 Write Customer Data	Dec	254 52	Data	v5.6
	Hex	FE 34	Data	
	ASCII	■ 4	Data	

Saves a user defined block of data to non-volatile memory. Useful for storing display information for later use.

Data	Byte [16]	User defined data.
-------------	------------------	--------------------

9.2 Read Customer Data	Dec	254 53	v5.6
	Hex	FE 35	
	ASCII	■ 5	

Reads data previously written to non-volatile memory. Data is only changed when written, surviving power cycles.

Response	Byte [16]	Previously saved user defined data.
-----------------	------------------	-------------------------------------

9.3 Read Version Number	Dec	254 54	v5.6
	Hex	FE 36	
	ASCII	■ 6	

Causes display to respond with its firmware version number. Test.

Response	Byte	Convert to hexadecimal to view major and minor revision numbers.
-----------------	-------------	--

9.4 Read Module Type	Dec	254 55	v5.6
	Hex	FE 37	
	ASCII	■ 7	

Causes display to respond with its module number.

Response	Byte	Module number, see Sample Module Type Responses for a partial list.
-----------------	-------------	---

Table 22: Sample Module Type Responses

8	LK202-25	14	VK202-25
85	LK202-25-USB	86	VK202-25-USB

7 Appendix

7.1 Command Summary

Available commands below include identifying number, required parameters, the returned response and an indication of whether settings are remembered always, never, or with remember set to on.

Table 23: Communication Command Summary

Name	Dec	Hex	ASCII	Parameters	Response	Remembered
Change Baud Rate	57	39	9	Byte	None	Always
Change I ² C Slave Address	51	33	3	Byte	None	Always
Transmission Protocol Select	160	A0	á	Byte	None	Remember On
Set a Non-Standard Baud Rate	164	A4	ñ	Byte	None	Always

Table 24: Text Command Summary

Name	Dec	Hex	ASCII	Parameters	Response	Remembered
Clear Screen	88	58	X	None	None	Never
Change the Start Up Screen	64	40	@	Byte[]	None	Always
Auto Scroll On	81	51	Q	None	None	Remember On
Auto Scroll Off	82	52	R	None	None	Remember On
Set Auto Line Wrap On	67	43	C	None	None	Remember On
Set Auto Line Wrap Off	68	44	D	None	None	Remember On
Set Cursor Position	71	47	G	Byte[2]	None	Never
Go Home	72	48	H	None	None	Never
Move Cursor Back	76	4C	L	None	None	Never
Move Cursor Forward	77	4D	M	None	None	Never
Underline Cursor On	74	4A	J	None	None	Remember On
Underline Cursor Off	75	4B	K	None	None	Remember On
Blinking Block Cursor On	83	53	S	None	None	Remember On
Blinking Block Cursor Off	84	54	T	None	None	Remember On

Table 25: Special Character Command Summary

Name	Dec	Hex	ASCII	Parameters	Response	Remembered
Create a Custom Character	78	4E	N	Byte[9]	None	Remember On
Save Custom Characters	193	C1	ñ	Byte[10]	None	Always
Load Custom Characters	192	C0		Byte	None	Never
Save Start Up Screen Custom Characters	194	C2		Byte[9]	None	Always
Initialize Medium Numbers	109	6D	m	None	None	Never
Place Medium Numbers	111	6F	o	Row, Col, Digit	None	Never
Initialize Horizontal Bar	104	68	h	None	None	Never
Place Horizontal Bar Graph	124	7C		Col, Row, Dir, Length	None	Never
Initialize Narrow Vertical Bar	115	73	s	None	None	Never
Initialize Wide Vertical Bar	118	76	v	None	None	Never
Place Vertical Bar	61	3D	=	Col, Length	None	Never

Table 26: General Purpose Output Command Summary

Name	Dec	Hex	ASCII	Parameters	Response	Remembered
General Purpose Output On	86	56	V	Byte	None	Never
General Purpose Output Off	87	57	W	Byte	None	Never
Set Start Up GPO State	195	C3		Byte[2]	None	Always

Table 27: Dallas One-Wire Command Summary

Name	Dec	Hex	ASCII	Parameters	Response	Remembered
Search for a One-Wire Device	200, 2	C8, 02	, sOT	None	Byte[14]	Never
Dallas One-Wire Transaction	200, 1	C8, 01	, sTX	Byte[3], Byte[]	Byte[]	Never

Table 28: Keypad Command Summary

Name	Dec	Hex	ASCII	Parameters	Response	Remembered
Auto Transmit Key Presses On	65	41	A	None	None	Remember On
Auto Transmit Key Presses Off	79	4F	`	None	None	Remember On
Poll Key Press	38	26	&	None	Byte	Never
Clear Key Buffer	69	45	E	None	None	Never
Set Debounce Time	85	55	U	Byte	None	Remember On
Set Auto Repeat Mode	126	7E	DEL	Mode	None	Remember On
Auto Repeat Mode Off	96	60	`	None	None	Remember On
Assign Keypad Codes	213	D5		Byte[25], Byte[25]	None	Always

Table 29: Display Functions Command Summary

Name	Dec	Hex	ASCII	Parameters	Response	Remembered
Backlight On	66	42	B	Byte	None	Remember On
Backlight Off	70	46	F	None	None	Remember On
Set Brightness*	153	99	Ö	Byte	None	Remember On
Set and Save Brightness*	152	98	ÿ	Byte	None	Always
Set Contrast*	80	50	P	Byte	None	Remember On
Set and Save Contrast*	145	91	æ	Byte	None	Always
Set VFD Brightness**	89	59	Y	Byte	None	Remember On
Set and Save VFD Brightness**	145	91	æ	Byte	None	Always

Note*: LCD Model specific command.

Note:** VFD Model specific command.

Table 30: Data Security Command Summary

Name	Dec	Hex	ASCII	Parameters	Response	Remembered
Set Remember	147	93	ô	Byte	None	Always
Set Data Lock	202, 245, 160	CA, F5, A0	⏟, , á	Byte	None	Remember On
Set and Save Data Lock	203, 245, 160	CB, F5, A0	⏟, , á	Byte	None	Always

Table 31: Miscellaneous Command Summary

Name	Dec	Hex	ASCII	Parameters	Response	Remembered
Write Customer Data	52	34	4	Byte[16]	None	Always
Read Customer Data	53	35	5	None	Byte[16]	Never
Read Version Number	54	36	6	None	Byte	Never
Read Module Type	55	37	7	None	Byte	Never

7.2 Character Sets

		Higher 4-bit (D4 to D7) of Character Code (Hexadecimal)															
		0	1	2	3	4	5	6	7	8	9	A	B	C	D	E	F
Lower 4-bit (D0 to D3) of Character Code (Hexadecimal)	0	CG RAM (1)	±		0	OP	'	P	9	è	à		ı	ı	ı	ı	
	1	CG RAM (2)	≡	.	1	A	Q	a	q	u	æ	ı		ı	ı	ı	ı
	2	CG RAM (3)	7	"	2	B	R	b	r	e	æ	ı	ı	ı	ı	ı	ı
	3	CG RAM (4)	Ł	#	3	O	S	s	š	š	ö	ö		ı	ı	ı	ı
	4	CG RAM (5)	ı	\$	4	D	T	t	ä	ä	ı	ı		ı	ı	ı	ı
	5	CG RAM (6)	ı	%	5	E	U	u	ä	ä	ı	ı		ı	ı	ı	ı
	6	CG RAM (7)	ı	&	6	F	V	v	ä	ä	ı	ı		ı	ı	ı	ı
	7	CG RAM (8)	ı	'	7	B	V	v	š	š	ı	ı		ı	ı	ı	ı
	8	CG RAM (1)	ı	(8	H	X	x	ä	ä	ı	ı		ı	ı	ı	ı
	9	CG RAM (2)	ı)	9	I	Y	y	ä	ä	ı	ı		ı	ı	ı	ı
	A	CG RAM (3)	ı	*		J	Z	z	ä	ä	ı	ı		ı	ı	ı	ı
	B	CG RAM (4)	ı	+		K	C	c	ä	ä	ı	ı		ı	ı	ı	ı
	C	CG RAM (5)	ı	,		L	V	v	ä	ä	ı	ı		ı	ı	ı	ı
	D	CG RAM (6)	ı	-		M	N	n	ä	ä	ı	ı		ı	ı	ı	ı
	E	CG RAM (7)	ı	.		N	ı	ı	ä	ä	ı	ı		ı	ı	ı	ı
	F	CG RAM (8)	ı	/		O	L	ä	ä	ı	ı		ı	ı	ı	ı	ı

Figure 17: LCD Model European Character Set

		Higher 4-bit (D4 to D7) of Character Code (Hexadecimal)																				
		0	1	2	3	4	5	6	7	8	9	A	B	C	D	E	F					
Lower 4-bit (D0 to D3) of Character Code (Hexadecimal)	0	CG RAM (1)			0	1	2	3	4	5	6	7	8	9	A	B	C	D	E	F		
	1	CG RAM (2)		!	!	!	!	!	!	!	!	!	!	!	!	!	!	!	!	!	!	
	2	CG RAM (3)		"	"	"	"	"	"	"	"	"	"	"	"	"	"	"	"	"	"	
	3	CG RAM (4)		#	#	#	#	#	#	#	#	#	#	#	#	#	#	#	#	#	#	
	4	CG RAM (5)		\$	\$	\$	\$	\$	\$	\$	\$	\$	\$	\$	\$	\$	\$	\$	\$	\$	\$	
	5	CG RAM (6)		%	%	%	%	%	%	%	%	%	%	%	%	%	%	%	%	%	%	%
	6	CG RAM (7)		&	&	&	&	&	&	&	&	&	&	&	&	&	&	&	&	&	&	&
	7	CG RAM (8)		'	'	'	'	'	'	'	'	'	'	'	'	'	'	'	'	'	'	'
	8	CG RAM (1)		(((((((((((((((((((
	9	CG RAM (2))))))))))))))))))))
	A	CG RAM (3)		*	*	*	*	*	*	*	*	*	*	*	*	*	*	*	*	*	*	*
	B	CG RAM (4)		+	+	+	+	+	+	+	+	+	+	+	+	+	+	+	+	+	+	+
	C	CG RAM (5)		,	,	,	,	,	,	,	,	,	,	,	,	,	,	,	,	,	,	,
	D	CG RAM (6)		-	-	-	-	-	-	-	-	-	-	-	-	-	-	-	-	-	-	-
	E	CG RAM (7)	
	F	CG RAM (8)		/	/	/	/	/	/	/	/	/	/	/	/	/	/	/	/	/	/	/

Figure 18: VFD Model Japanese Character Set

7.3 Block Diagram

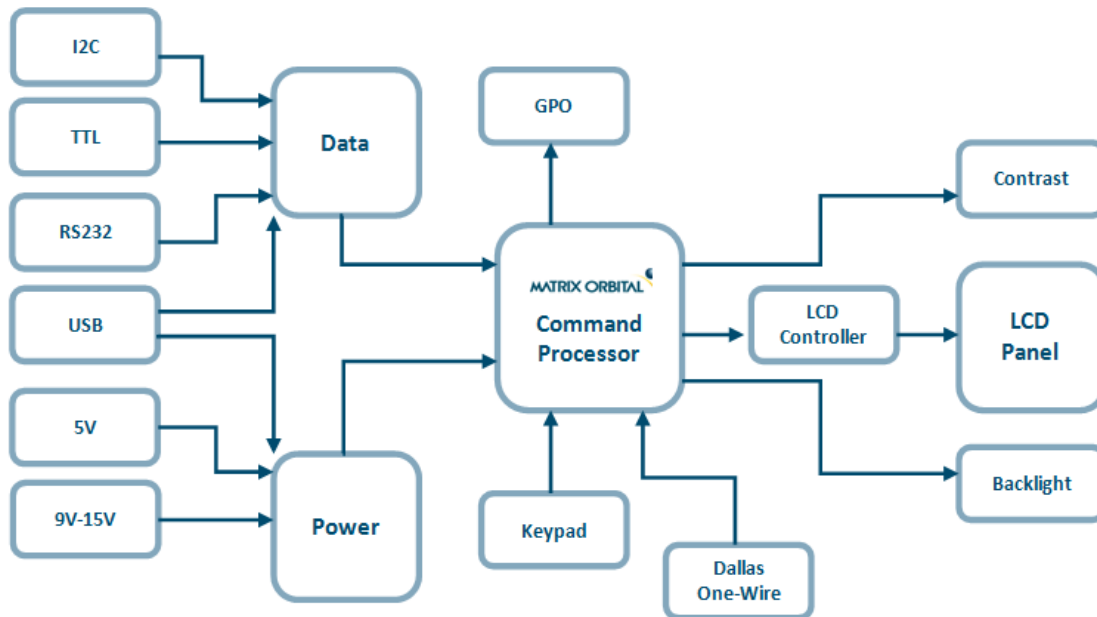

Figure 19: Functional Diagram

7.4 Environmental Specifications

Table 32: Environmental Limits

	LCD Standard	LCD Extended (-E)	VFD Standard	VFD Extended (-E)
Operating Temperature	0°C to +50°C	-20°C to +70°C	-20°C to +70°C	-40°C to +85°C
Storage Temperature	-10°C to +60°C	-30°C to +80°C	-40°C to +85°C	-50°C to +85°C
Operating Relative Humidity	Maximum 90% non-condensing		Maximum 80% non-condensing	
Thermal Shock	Maximum 10°C /min			

7.5 Electrical Tolerances

Current Consumption

Table 33: Current Consumption

Board	+	Backlight	+	GPOs
40mA		60 to 250 mA		20mA each maximum

Table 34: Backlight Current Draw

YG & IY	R, FG & FA	GW, WB, FW & FB	VFD
130mA	150mA	60mA	170mA

Input Voltage Specifications

Table 35: Voltage Specifications

Standard	Wide Voltage (-V)
4.75-5.25V	9.0-15.0V

7.6 Dimensional Drawings

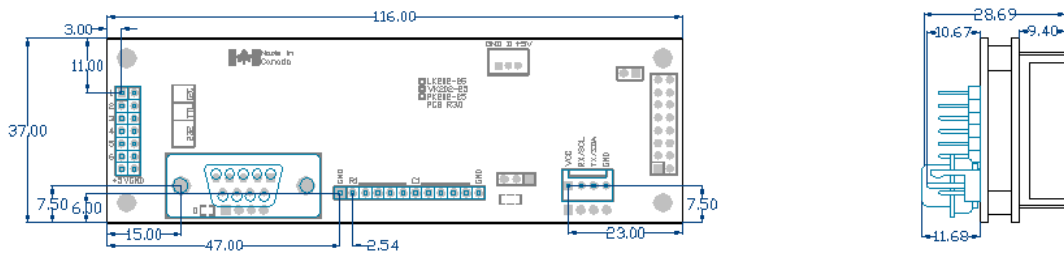
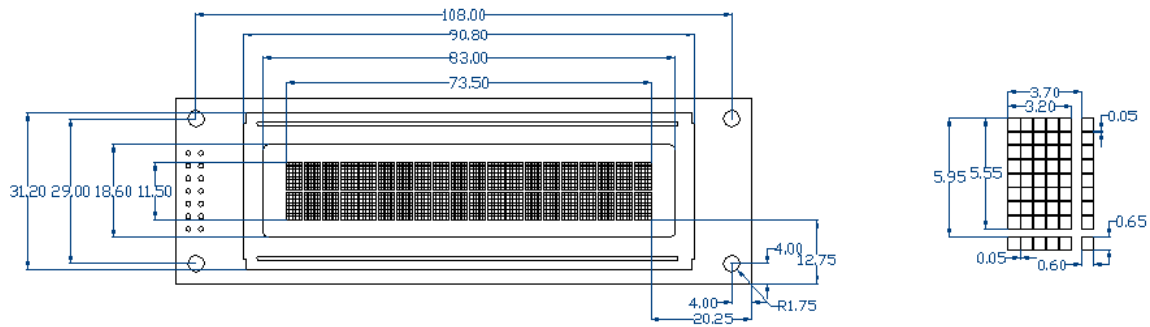

Figure 20: LK202-25 Dimensional Drawing

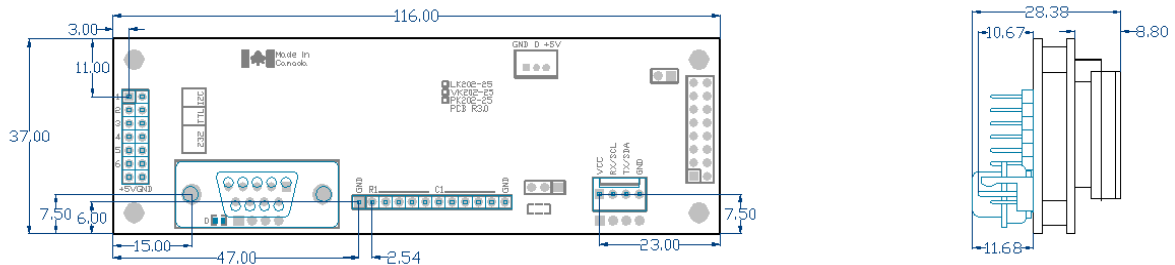
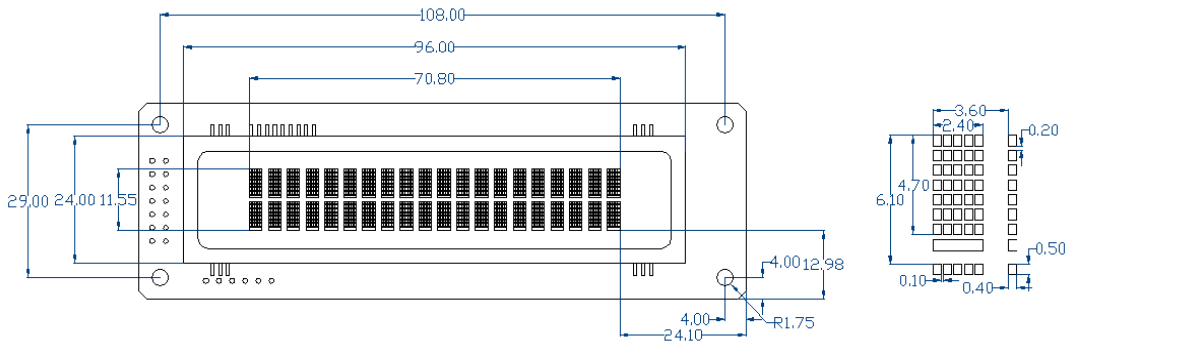

Figure 21: VK202-25 Dimensional Drawing

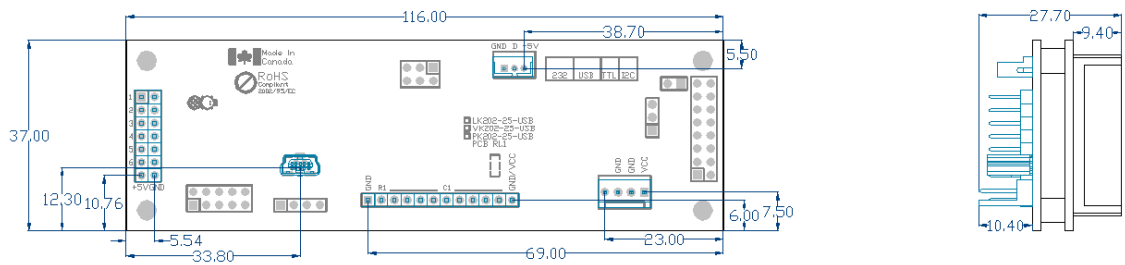
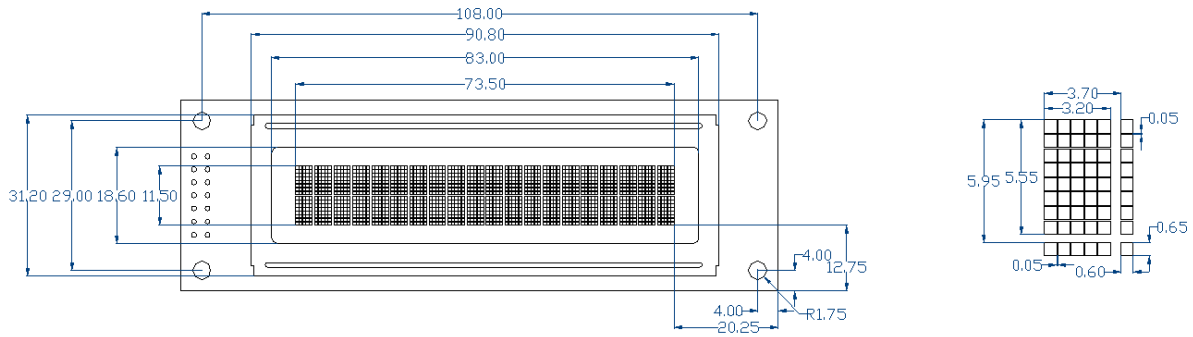

Figure 22: LK202-25-USB Dimensional Drawing

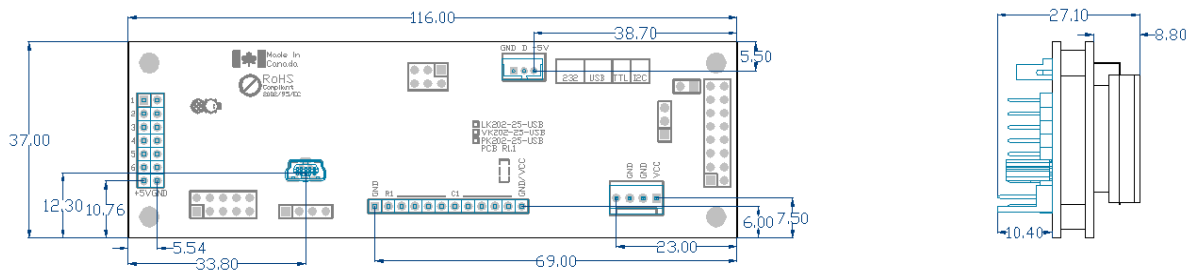
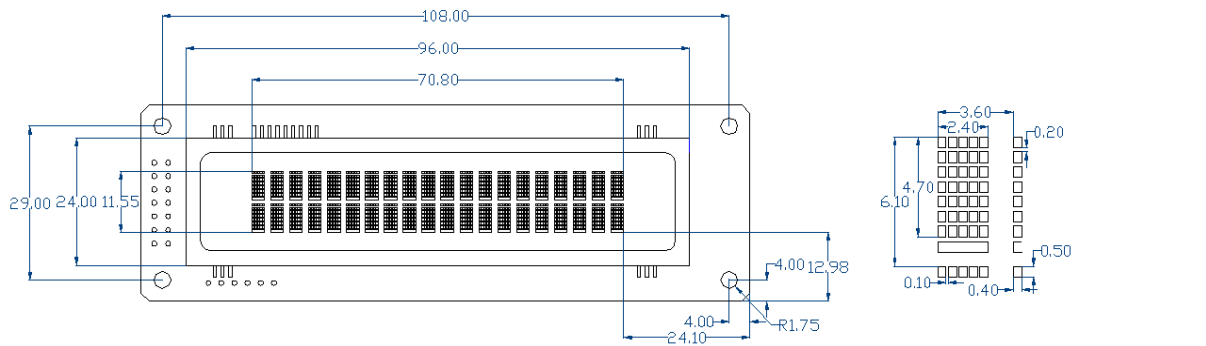

Figure 23: VK202-25-USB Dimensional Drawing

7.7 Optical Characteristics

Table 36: Display Optics

	LCD Model	VFD Model	
Module Size	116.00 x 37.00 x 29.0		mm
Viewing Area	63.0 x 18.6	96.0 x 24.0	mm
Active Area	73.5 x 11.5	70.8 x 11.6	mm
Character Size	3.20 x 5.55	2.40 x 4.70	mm
Character Pitch	3.70 x 5.95	3.60 x 6.10	mm
Pixel Size	0.55 x 0.60	0.40 x 0.50	mm
Pixel Pitch	0.60 x 0.65	0.50 x 0.70	mm
Viewing Direction	12	N/A	O'clock
Viewing Angle	-30 to +30	N/A	°
Contrast Ratio	3	N/A	
VFD Brightness	N/A	350	cd/m2
Backlight Half-Life	50,000	N/A	Hours

8 Ordering

8.1 Part Numbering Scheme

Table 37: Part Numbering Scheme

LK	-202	-25	-FW	-V		-E
1	2	3	4	5	6	7

8.2 Options

Table 38: Display Options

#	Designator	Options
1	Product Type	LK: Liquid Crystal Display with Keypad Input VK: Vacuum Florescent Display with Keypad Input
2	Display Size	-202: 20 columns by 2 rows
3	Keypad Size	25: 25 key maximum
4	Colour	*NP: Standard (YG for LCD/ no filter for VFD) -GW: Grey Text with White Background -WB: White Test with Blue Background -IY: Yellow-Green Text with Black Background (Inverse Display) -R: Red Text with Black Background (Inverse Display) FA: Amber Text with Black Background (FFSTN Display) FB: Blue Text with Black Background (FFSTN Display) FG: Green Text with Black Background (FFSTN Display) FW: White Text with Black Background (FFSTN Display)
5	Voltage	*NP: Standard Voltage -V: Wide Voltage
6	Protocol	*NP: Standard Model -USB: USB Only Model
7	Temperature	*NP: Standard -E: Extended Temperature

***Note:** NP means No Populate; skip this designator in the part number and move to the next option.

8.3 Accessories





Power

Table 39: Power Accessories

PCS	Standard Power Cable	
-----	----------------------	---

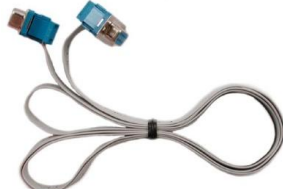

Communication

Table 40: Communication Accessories

CSS1FT	1 ft. Serial Cable	
CSS4FT	4 ft. Serial Cable	
EXTMUSB3FT	Mini-USB Cable	
INTMUSB3FT	Internal Mini-USB Cable	
SCCPC5V	Serial Communication/5V Power Cable	
BBC	Breadboard Cable	

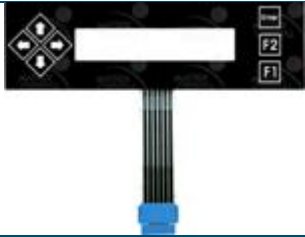

Peripherals

Table 41: Peripheral Accessories

KPP4x4	16 Button Keypad	
KPP20A-XX*	7 Button Keypad Overlay	
Temperature Probe	Dallas One-Wire Temperature Probe	

Mounting

Table 42: Mounting Accessories

B2041-XX**	Mounting Bracket with Coloured Overlay	
B204A-XX*	Mounting Bracket with Keyed Overlay	
MK2041-XX**	Coloured Overlay with Drill Guide	

***Note:** Keyed overlays are available in Black (-BK), Silver (-SK), Red (-DR), and Beige(no part extension) Vinyl.

****Note:** Non-keyed overlays are available in Black Vinyl (-BK), Black Brushed Aluminum (-BL), Silver Brushed Aluminum (-AL), and Beige Vinyl (no part extension).

9 Definitions

ASCII: American standard code for information interchange used to give standardized numeric codes to alphanumeric characters.

BPS: Bits per second, a measure of transmission speed.

DOW: Dallas One-Wire protocol, similar to I²C, provides reduced data rates at a greater distance. One wire carries data, while two others supply power and ground. Matrix Orbital tests non-parasitic devices only, those that do not draw power from the data line; however, some parasitic devices may work.

FFSTN: Double film super-twisted nematic in reference to an LCD. The addition of two layers of film between the STN display and polarizer improves contrast.

GPO: General purpose output, used to control peripheral devices from a display.

GUI: Graphical user interface.

Hexadecimal: A base 16 number system utilizing symbols 0 through F to represent the values 0-15.

I²C: Inter-integrated circuit protocol uses clock and data lines to communicate short distances at slow speeds from a master to up to 128 addressable slave devices. A display is a slave device.

LSB: Least significant bit or byte in a transmission, the rightmost when read.

MSB: Most significant bit or byte in a transmission, the leftmost when read.

RS232: Recommended standard 232, a common serial protocol. A low level is -30V, a high is +30V.

SDA: Serial data line used to transfer data in I²C protocol. This open drain line should be pulled high through a resistor. Nominal values are between 1K and 10K Ω.

SCL: Serial clock line used to designate data bits in I²C protocol. This open drain line should be pulled high through a resistor. Nominal values are between 1K and 10K Ω.

STN: Super-twisted nematic in reference to an LCD. In a relaxed or nematic state, crystals orientate themselves in the same direction and allow light to pass. In an excited state these crystals align to block light. Super-twisted crystals move from 180 to 270 degrees providing greater contrast than TN models.

TTL: Transistor-transistor logic applied to serial protocol. Low level is 0V while high logic is 5V.

10 Contact

Sales

Phone: 403.229.2737

Email: sales@matrixorbital.ca

Support

Phone: 403.204.3750

Email: support@matrixorbital.ca

Online

Purchasing: www.matrixorbital.com

Support: www.matrixorbital.ca