



# LK204-25 / VK204-25

---

Including LK204-25-422, LK204-25-USB, VK204-25-422, and VK204-25-USB

## Technical Manual

Revision 1.3

**PCB Revision: 3.0 or Higher**

**Firmware Revision: 7.0 or Higher**

## Revision History

Revision	Description	Author
1.3	Added Power Directions for the RS422 Model	Clark
1.2	Added Command Summary Addition	Clark
1.1	Grammatical and Ease of Reading Enhancements	Clark
1.0	Initial Release	Clark

## Contents

Revision History .....	2
Contents .....	3
Introduction .....	5
Quick Connect Guide .....	6
Standard Module .....	6
Recommended Parts .....	6
Serial Connections .....	7
I <sup>2</sup> C Connections .....	8
USB Module .....	9
Recommended Parts .....	9
USB Connections .....	10
RS422 Module .....	11
RS422 Connections .....	11
Software .....	12
Hyperterminal .....	12
uProject .....	13
Application Notes .....	13
Hardware .....	14
Standard Model .....	14
Communication/Power Header .....	14
Serial DB9 Connector .....	14
Power Through DB9 Jumper .....	15
Protocol Select Jumpers .....	15
USB Model .....	16
Mini USB Connector .....	16
Alternate USB Header .....	16
Alternate Power Connector .....	16
RS422 Model .....	17
RS422 Header .....	17
Alternate Power Connector .....	17
Common Features .....	18

General Purpose Outputs .....	18
Dallas One-Wire Connector .....	18
Keypad Header.....	19
Troubleshooting.....	20
Power .....	20
Display.....	20
Communication.....	21
Manual Override.....	21
Commands .....	22
1. Communications .....	22
2. Text .....	23
3. Special Characters.....	26
4. General Purpose Output.....	29
5. Dallas One-Wire .....	30
6. Keypad.....	31
7. Display Functions .....	33
8. Data Security.....	35
9. Miscellaneous .....	36
Appendix .....	37
Command Summary .....	37
Character Sets .....	39
Environmental Specifications.....	41
Electrical Tolerances .....	41
Optical Characteristics .....	41
Dimensional Drawings .....	42
Ordering.....	44
Part Numbering Scheme .....	44
Options.....	44
Accessories.....	45
Definitions.....	47
Contact.....	47

## Introduction

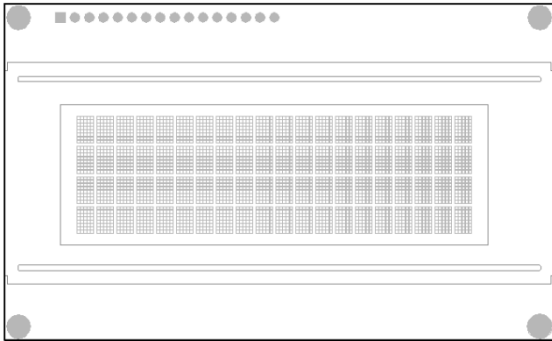

*Figure 1: LK204-25 Display*

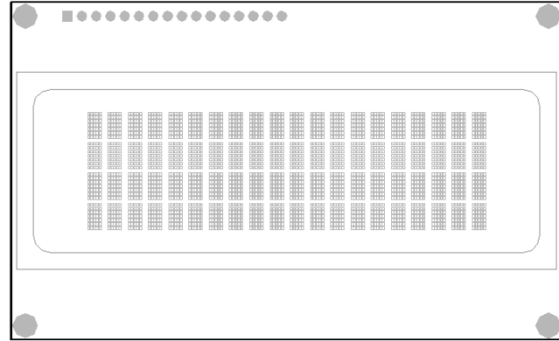

*Figure 2: VK204-25 Display*

The LVK204-25 is an intelligent alphanumeric liquid crystal display designed to decrease development time by providing an instant solution to any project. In addition to the RS232, TTL and I2C protocols available in the standard model, USB and RS422 communication models allow the LVK204-25 to be connected to a wide variety of host controllers. Communication speeds of up to 115.2kbps for serial protocols and 100kbps for I<sup>2</sup>C ensure lightning fast data display.

The simple command structure permits easy software control of many settings including backlight brightness, screen contrast, and baud rate. On board memory provides up to forty custom characters which can be saved within the unit and recalled for start screens, bar graphs or larger numbers.

User input is available through a five by five matrix style keypad, and six general purpose outputs provide simple switchable five volt sources. In addition, a Dallas One-Wire header provides a convenient communication interface for up to thirty-two devices.

The versatile LVK204-25, with all the features mentioned above, is available in a variety of colour, voltage, and temperature options to suit almost any application.

# Quick Connect Guide

## Standard Module

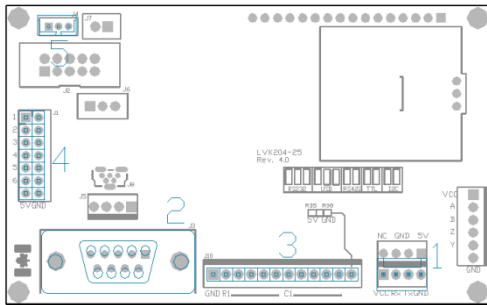

Figure 3: Standard Connections

Table 1: Standard Headers

#	Header	Mate
1	Communication/Power	SCCPC5V/BBC
2	DB9	CSS1FT/CSS4FT
3	Keypad	KPP4x4
4	GPO	None Offered
5	Dallas One-Wire	Temperature Probe

The standard version of the LVK204-25 allows for user configuration of three common communication protocols. First, the unit can communicate using serial protocol at either RS323 or TTL voltage levels. Second, it can communicate using the Inter-Integrated Circuit, or I<sup>2</sup>C protocol. Connections for each protocol can be accessed through the four pin Communication/Power Header as outlined in the Serial Connections and I<sup>2</sup>C Connections sections below.

### Recommended Parts



Figure 4: Communication/Power Cable (SCCPC5V)

The most common cable choice for any standard Matrix Orbital display, the Communication/Power Cable offers a simple connection to the unit with familiar interfaces. DB9 and floppy power headers provide all necessary input to drive your display.



Figure 5: Breadboard Cable (BBC)

For a more flexible interface to the LVK204-25, a Breadboard Cable may be used. This provides a simple four wire connection that is popular among developers for its ease of use in a breadboard environment.

## Serial Connections

The serial interface provides a classic connection to the LVK204-25. The Communication/Power Cable is most commonly used for this set up as it provides connections for DB9 serial and floppy power cables. To place your board in serial mode, adhere to the steps laid out below.

1. Set the Protocol Select Jumpers.
  - RS232: Connect the three jumpers\* in the 232 protocol box with the zero ohm jumper resistors provided or an alternate wire or solder solution.
  - TTL: Connect the two jumpers\* in the TTL protocol box.

**\*Note:** Jumpers must be removed from all protocol boxes save for the one in use.

2. Make the connections.
  - a. Connect the four pin female header of the Communication/Power Cable to the Communication/Power Header of your LVK204-25.
  - b. Insert the male end of your serial cable to the corresponding DB9 header of the Communication/Power Cable and mate the female connector with the desired communication port of your computer.
  - c. Select an unmodified floppy cable from a PC power supply and connect it to the power header of the Communication/Power Cable.
3. Create.
  - uProject or hyperterminal will serve to get you started, and then move on with your own development. Instructions for the former can be found below and a variety of application notes are available for the latter at [www.matrixorbital.ca/appnotes](http://www.matrixorbital.ca/appnotes).

## I<sup>2</sup>C Connections

A more advanced connection to the LVK204-25 is provided by the I<sup>2</sup>C protocol setting. This is best accomplished using a breadboard and the Breadboard Cable. Power must be supplied from your breadboard or another external source. To dive right into your application and use the LVK204-25 in I<sup>2</sup>C mode, get started with the guidelines below.

1. Set the Protocol Select switches.
  - I<sup>2</sup>C: Ensure that the two I<sup>2</sup>C jumpers in the corresponding protocol box are connected while all others are open.
2. Make the connections.
  - a. Connect the Breadboard Cable to the Communication/Power Header on your LVK204-25 and plug the four leads into your breadboard. The red lead will require power, while the black should be connected to ground, and the green and yellow should be connected to your controller clock and data lines respectively.
  - b. Pull up the clock and data lines to five volts using a resistance between one and ten kilohms on your breadboard.
3. Create.
  - This time you're on your own. While there are many examples within the Matrix Orbital AppNote section, [www.matrixorbital.ca/appnotes](http://www.matrixorbital.ca/appnotes), too many controllers and languages exist to cover them all. If you get stuck in development, it is possible to switch over to another protocol on the standard board, and fellow developers are always on our forums for additional support.



## USB Module

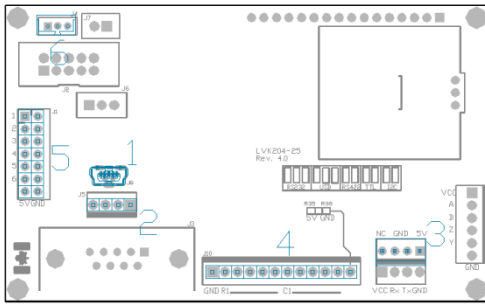

Figure 6: USB Connections

Table 2: Standard Headers

#	Header	Mate
1	Mini USB	EXTMUSB3FT/ INTMUSB3FT
2	Alternate USB	None Offered
3	Alternate Power	PCS
4	Keypad	KPP4x4
5	GPO	None Offered
6	Dallas One-Wire	Temperature Probe

The LVK204-25-USB offers a single USB protocol for easy connection to a host computer. The simple and widely available protocol can be accessed using the on board mini B style USB connector as outlined in the USB Connections section.

## Recommended Parts



Figure 7: External Mini USB Cable (EXTMUSB3FT)

The External Mini USB cable is recommended for the LVK204-25-USB display. It will connect to the miniB style header on the unit and provide a connection to a regular A style USB connector, commonly found on a PC.

## USB Connections

The USB connection is the quickest, easiest solution for PC development. After driver installation, the LVK204-25-USB will be accessible through a virtual serial port, providing the same result as a serial setup without the cable hassle. To connect to your LVK204-25-USB, please follow the steps below.

1. Set the Protocol Select Jumpers.
  - USB: The LVK204-25-USB offers USB protocol only. Model specific hardware prevents this unit from operating in any other protocol, and does not allow other models to operate in the USB protocol. Protocol Select Jumpers on the USB model cannot be moved.
2. Make the connections.
  - Plug the mini-B header of your External Mini USB Cable into your LVK204-25-USB and the regular USB header into your computer USB jack.
3. Install the drivers.
  - a. Download the latest drivers at [www.matrixorbital.ca/drivers](http://www.matrixorbital.ca/drivers), and save them to a known location.
  - b. When prompted, install the USB bus controller driver automatically.
  - c. If asked, continue anyway, even though the driver is not signed.
  - d. When the driver install is complete, your display will turn on, but communication will not yet be possible.
  - e. At the second driver prompt, install the serial port driver automatically.
  - f. Again, if asked, continue anyway.
4. Create.
  - Use uProject or hyperterminal to get started, and then move on with your own development. Instructions for the former can be found below and a number of application notes are available for the latter at [www.matrixorbital.ca/appnotes](http://www.matrixorbital.ca/appnotes).

## RS422 Module

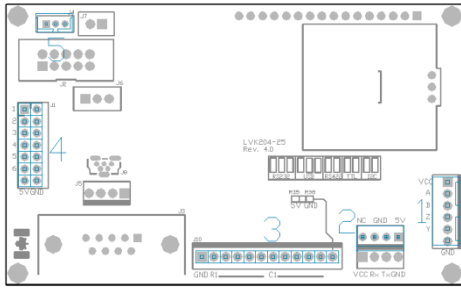

Figure 8: RS422 Connections

Table 3: Standard Headers

#	Header	Mate
1	RS422	16-30 AWG Wire
2	Alternate Power	PCS
3	Keypad	KPP4x4
4	GPO	None Offered
5	Dallas One-Wire	Temperature Probe

The LVK204-25-422 provides an industrial alternative to the standard RS232 communication protocol. Rather than single receive and transmit lines, the RS422 model uses a differential pair for each of the receive and transmit signals to reduce degradation and increase transmission lengths. Power can be transmitted at distance to a -VPT module or supplied from the immediate vicinity to a regular or -V unit. RS422 signals are available in a six pin connector as described in the RS422 Connections section.

### RS422 Connections

The LVK204-25-422 provides a robust RS422 interface to the display line. For this interface, a series of six wires are usually screwed into the RS422 terminal block provided. An alternate header is also available to provide local power to a regular or -V unit. To connect to your LVK204-25-422, follow the steps below.

1. Set the Protocol Select Jumpers.
  - RS422: The LVK204-25-422 offers only RS422 protocol and does not require any jumper changes.
2. Make the connections.
  - a. Screw one wire; sized 16 to 30 on the American Wire Gauge, into each of the six terminal block positions. When local power is supplied, a floppy cable may link to the alternate power header.
  - b. Connect the Vcc wire to the positive terminal of your power supply and the GND terminal to the negative or ground lead to provide appropriate power as in Table 40.
  - c. Secure the A and B wires to your non-inverting and inverting output signals respectively, while attaching the Z and Y wires to your inverting and non-inverting inputs.
3. Create.
  - In a PC environment, uProject or hyperterminal will serve to get you started. In addition, a variety of application notes are also available in a number of different languages to aid in development. Instructions for the former can be found below and the simple C# example at [www.matrixorbital.ca/appnotes](http://www.matrixorbital.ca/appnotes) is a great first reference for the latter.

## Software

The multiple communication protocols available and simple command structure of the LVK204-25 means that a variety of applications can be used to communicate with the display. Text is sent to the display as a character string, for example, sending the decimal value 41 will result in an 'A' appearing on the screen. A number of control characters are also activated. Commands are merely values prefixed with a special command byte, 254 in decimal. While many software programs are available to communicate with the LVK204-25, a number of more common samples are detailed in depth below.

Table 4: Reserved Control Characters

Control Characters							
8	Backspace	10	Line feed / New line	12	Clear screen / New page	13	Carriage return

## Hyperterminal

Installed on most Windows computers, hyperterminal can be run by selecting run and typing 'hypertrm' in the command line. This basic program will allow communication between a PC and your display.

When starting up, a name must be given to your connection, and an icon may be chosen, neither is consequential. Next, it's important to select the appropriate communication port to which your display is connected. Finally, the settings below must be entered to complete the port setup.

Table 5: Hyperterminal Settings

BPS	Data Bits	Parity	Stop Bits	Flow Control
19200	8	None	1	None

Once a port is successfully set up, data can be sent to an attached display by typing on the keyboard. At this point, it may be helpful to echo keys to the monitor by selecting properties from the file menu and opening the ASCII settings from settings tab.

Commands can be sent to an attached display by issuing decimal commands using the number pad. While the ALT key is held down, four digit decimal values can be sent as a single ASCII character. For example, to clear the screen, try the following sequence.

**ALT +0254 ALT +0088**

Figure 9: Hyperterminal Command

Any commands or text desired can be sent to the communication port using this method to provide total control of any Matrix Orbital display.

## uProject

The Matrix Orbital alphanumeric display tuner, or uProject, is offered as a free download from the [www.matrixorbital.ca](http://www.matrixorbital.ca) support site. It allows the basic functionality of any display\* to be tested using a simple graphical user interface system.

While basic functionality can be tested using the GUI portion of the program, more advanced users will enjoy the scripting capability found in the uploader tab. Here commands can be stacked, run, and saved for later use. Although many commands are available to be dragged into the script dialog, perhaps the most powerful is the raw data command found in the other branch.

This command allows raw bytes to be sent to the display, permitting many different formats for entry and displaying in decimal notation. Any command from this manual may be entered in decimal notation separated by slashes.

**/254//88/**

*Figure 10: uProject Command*

Again, the clear screen command is sent to a connected display, this time using uProject raw data command style. Scripts can be run as a whole using the execute command from the script menu, or as single commands by selecting execute once. Before issuing commands, it is a good idea to ensure communication with a display is successful using some of the more basic GUI functions in the main window.

This program provides scratch pad upon which a tome of display projects and ideas can be assembled.

**\*Note:** The uProject AutoDetect function will not perform correctly when a USB display is connected. Please manually configure any USB display.

## Application Notes

Full demonstration programs and code are available for Matrix Orbital displays in the C# language from Simple C# AppNote Pack in the Matrix Orbital Application Note section at [www.matrixorbital.ca/appnotes](http://www.matrixorbital.ca/appnotes). Difficulty increases from beginner, with the Hello World program, to advanced with the Dallas One-Wire temperature reading application.

Many additional applications are available in a number of different programming languages. These programs are meant to showcase the capability of the display and are not intended to be integrated into a final design. For additional information regarding code, please read the On Code document also found on the support site.

# Hardware

## Standard Model

### Communication/Power Header

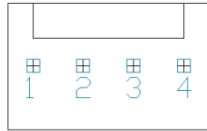

Figure 11: Communication/Power Header

Table 6: Communication/Power Pinout

Pin	Function
1	Vcc
2	Rx (SCL)
3	Tx (SDA)
4	Gnd

The Communication/Power Header provides a standard connector for interfacing to the LVK204-25. Voltage is applied through pins one and four of the four pin Communication/Power Header. Please ensure the correct voltage input for your display by referencing the electrical specifications in Table 40 before connecting power. Pins two and three are reserved for serial transmission, using either the RS-232/TTL or clocking data through the I<sup>2</sup>C protocol, depending on what has been selected by the Protocol Select Jumpers. The versatile Tyco 640456-4-LF style header employed here can be mated to a wide array of female connectors for a perfect fit in any project.

### Serial DB9 Connector

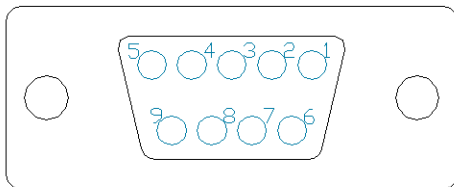

Figure 12: Serial DB9 Connector

Table 7: Serial DB9 Pinout

Pin	Function
5	Gnd
3	Rx
2	Tx
9	NC/Vcc*

The LVK204-25 provides a DB-9 Connector to readily interface with serial devices using EIA232 standard signal levels. It is also possible to communicate at TTL levels of 0 to +5V by setting the Protocol Select Jumpers to TTL. As an added feature it is also possible to apply power through pin 9 of the DB-9 Connector in order to reduce cable clutter. A standard male DB9 header will provide the perfect mate for this connector.

**\*Note:** Do not apply voltage through pin 9 of the DB-9 Connector AND through the Communication/Power Header at the same time.

### Power Through DB9 Jumper

In order to provide power through pin 9 of the DB-9 Connector you must connect the Power Through DB-9 Jumper labelled R17, as illustrated below. This connection can be made using a zero ohm resistor, recommended size 0603, or a solder bridge. The LVK204-25 allows all voltage models to use the power through DB-9 option, see the electrical specifications in Table 40 for voltage requirements.

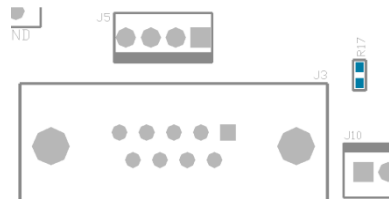

*Power Through DB9 Jumper*

### Protocol Select Jumpers

The Protocol Select Jumpers provide the means necessary to toggle the standard LVK204-25 model between RS-232, TTL and I<sup>2</sup>C protocols. As a default, the jumpers are set to RS-232 mode with solder jumps on the 232 jumpers. In order to place the display module in I<sup>2</sup>C mode you must first remove the solder jumps from the 232 jumpers and then place them on the I<sup>2</sup>C jumpers. The display will now be in I<sup>2</sup>C mode and have a default slave address of 80, unless it has been changed. Similarly, in order to change the display to TTL mode, simply remove the zero ohm resistors from the 232 or I<sup>2</sup>C jumpers and solder them to the TTL jumpers. Protocol changes are only supported on the standard unit.

## USB Model

### Mini USB Connector

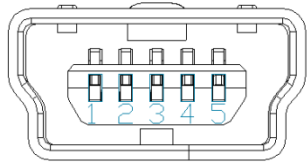

Figure 13: Mini USB Connector

Table 8: Mini USB Pinout

Pin	Function
1	Vcc
2	D-
3	D+
5	Gnd

The LVK204-25-USB comes with a familiar Mini USB Connector to fulfill both communication and power needs. The standard MiniB style header can be connected to any other USB style using the appropriate cable. Most commonly used with a PC, this connection creates a virtual com port that offers a simple power solution with a familiar communication scheme.

### Alternate USB Header

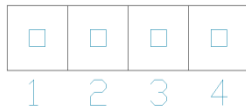

Figure 14: Alternate USB Header

Table 9: Alternate USB Pinout

Pin	Function
1	Gnd
2	D+
3	D-
4	Vcc

Some advanced applications may prefer the straight four pin connection offered through the Optional Alternate USB Header. This header offers power and communication access in a simple interface package. The Optional Alternate USB Header may be added to the LK402-25-USB for an added charge as part of a custom order. Please use the Contact section to request more information from the friendly Matrix Orbital sales team.

### Alternate Power Connector

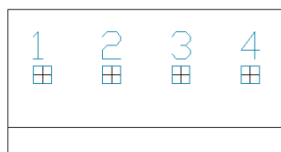

Figure 15: Alternate Power Connector

Table 10: Alternate Power Pinout

Pin	Function
1	NC
2	Gnd
3	Gnd
4	Vcc

The Alternate Power Connector provides the ability to power the LVK204-25-USB using a second cable. The Tyco 171825-4 style header is particularly useful for connecting to an unmodified floppy power cable from a PC power supply for a simple bench power solution.



## RS422 Model

### RS422 Header

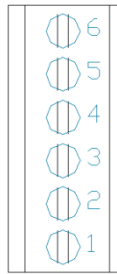

Figure 16: RS422 Header

Table 11: RS422 Pinout

Pin	Function
1	Gnd
2	Rx (Y)
3	Inv Rx (Z)
4	Inv Tx (B)
5	Tx (A)
6	Vcc

The six pin RS422 interface header of the LVK204-25-422 offers power and ground connections as well as two differential pair communication lines. Regular and inverted lines are provided for both receive and transmit signals. Power is supplied locally to the regular or -V variants while the -VPT can receive power over a distance. The Tyco 282834-6 style header is most suited to a simple wire connection.

### Alternate Power Connector

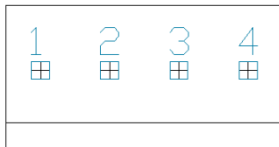

Figure 17: Alternate Power Connector

Table 12: Alternate Power Pinout

Pin	Function
1	NC
2	Gnd
3	Gnd
4	Vcc

The Alternate Power Connector provides the ability to power the LVK204-25-422 using a second cable. This is particularly useful for the regular or -V modules that are to be powered locally. The Tyco 171825-4 style header will fit a floppy power cable from a PC power supply for a simple bench power solution.

## Common Features

### General Purpose Outputs

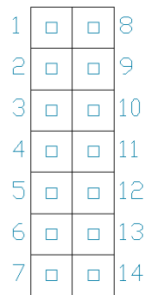

Figure 18: GPO Header

Table 13: GPO Pinout

Pin	Function	Pin	Function
1	GPO 1	8	Gnd
2	GPO 1	9	Gnd
3	GPO 1	10	Gnd
4	GPO 1	11	Gnd
5	GPO 1	12	Gnd
6	GPO 1	13	Gnd
7	Vcc	14	Gnd

A unique feature of the LVK204-25 is the ability to control relays\* and other external devices using one of six General Purpose Outputs. Each can source up to 20mA of current at five volts when on or sink 10mA at zero volts when off. The two row, fourteen pin header can be interfaced to a number of female connectors to provide control to any peripheral devices required.

**\*Note:** If connecting a relay, be sure that it is fully clamped using a diode and capacitor in order to absorb any electro-motive force (EMF) which will be generated.

### Dallas One-Wire Connector

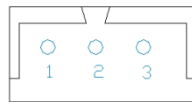

Figure 19: Dallas One-Wire Connector

Table 14: Dallas One-Wire Pinout

Pin	Function
1	Vcc
2	D
3	Gnd

In addition to the six general purpose outputs the LVK204-25 offers an Optional Dallas One-Wire bridge, to allow for an additional thirty two one-wire devices to be connected to the display. This header can be populated with a Tyco 173979 connector at an added cost by custom order only. Please use the Contact section to request for more information from the Matrix Orbital sales team.

## Keypad Header



Figure 20: Keypad Header

Table 15: Keypad Pinout

Pin	Function
1	Gnd
2	Row 1
3	Row 2
4	Row 3
5	Row 4
6	Row 5
7	Column 1
8	Column 2
9	Column 3
10	Column 4
11	Column 5
12	Gnd/Vcc*

To facilitate user input, the LVK204-25 provides a Keypad Interface Connector which allows a matrix style keypad of up to twenty-five keys to be directly connected to the display module. Key presses are generated when a short is detected between a row and a column. When a key press is generated, a character specific to that key press is automatically sent on the Tx communication line. If the display module is running in I<sup>2</sup>C mode, the “Auto Transmit Keypress” function may be turned off to allow the key presses to remain in the buffer so that they may be polled. The character that is associated with each key press may also be altered using the “Assign Key Codes” command. The straight twelve pin header of the Keypad Interface Connector will interface to a variety of different devices including the Matrix Orbital KPP4x4 keypad.

**\*Note:** The Ground / +5V pin is toggled by the jumper to the right of the keypad connector. Jump pads 1 & 2 for +5V or 2 & 3 for GND.

## Troubleshooting

### Power

In order for your Matrix Orbital display to function correctly, it must be supplied with the appropriate power. If the backlight is not illuminated, power is not applied correctly. Try following the tips below.

- First, make sure that you are using the correct power connector. Standard floppy drive power cables from your PC power supply may fit on the Communication/Power Header; however they do not have the correct pin out to provide power. Matrix Orbital supplies power cable adapters for connecting to a PC, which can be found in the accessories section.
- Next, check the power cable which you are using for continuity. If you don't have an ohm meter, try using a different power cable, if this does not help try using a different power supply.
- If power is applied through the DB9 connector, ensure that the Power Through DB9 Jumper is connected.
- If changes have been made to the protocol select block, ensure all the appropriate Protocol Select Jumpers are connected and all unused protocol jumpers are disconnected.
- The last step will be to check the power interface connector in use on your display. If the power connections have become loose, or you are unable to resolve the issue, please contact Matrix Orbital for more information.

### Display

If your display is powered successfully, the Matrix Orbital logo, or user created screen should display on start up. If this is not the case, check out these tips.

Ensure the contrast is not too high or too low. This can result in a darkened or blank screen respectively. See the

- Manual Override section to reset to default.
- Make sure that the start screen is not blank. It is possible to overwrite the Matrix Orbital logo start screen, if this happens the screen may be blank. Try writing to the display to ensure it is functional, after checking the contrast above.

## Communication

When communication of either text or commands is interrupted, try the steps below.

- First, check the communication cable for continuity. If you don't have an ohm meter, try using a different communication cable. If you are using a PC try using a different Com Port.
- Next, please ensure that the display module is set to communicate on the protocol that you are using, by checking the Protocol Select Jumpers.
- In serial protocol, ensure that the host system and display module are both communicating on the same baud rate. The default baud rate for the display module is 19200 bps.
- Match Rx from the LVK204-25 to the transmitting pin from your host and the Tx pin to the receiving pin.
- If you are communicating to the display via I<sup>2</sup>C\* please ensure that the data is being sent to the correct address. The default slave address for the display module is 80.
- In I<sup>2</sup>C mode, connect Rx to the data line of your controller and Tx to the data output.
- Unlock the display. See the Set and Save Data Lock command for more info.
- Finally, you may reset the display to its default settings using the Manual Override procedure outlined below.

**\*Note:** I<sup>2</sup>C communication will always require pull up resistors on SCL and SDA of one to ten kilohms.

## Manual Override

Should the settings of your display become altered in a way that dramatically impacts usability, the default settings can be temporarily restored. To override the display, please follow the steps below.

1. Disconnect power from your display.
2. Place a jumper on the middle two pins of the keypad header, R5 and C1.
3. Reconnect power to your unit, and wait for the start screen before removing the override jumper.
4. Settings will be temporarily\*\* overridden to the defaults listed in the Manual Override Settings table. At this point any important settings, such as contrast, backlight, or baud rate, should not only be set but saved so they remain when the override is removed.

Parameter	Value
Backlight	255
Contrast	128
Baud Rate	19200
I <sup>2</sup> C Address	80

Table 16: Manual Override Settings

**\*\*Note:** The display module will revert back to the old settings once turned off, unless desired settings are saved.

# Commands

## 1. Communications

<b>1.1. Changing the I2C Slave Address</b>	Dec	<b>254 51</b>	Address
	Hex	<b>FE 33</b>	Address
	ASCII	<b>■ 3</b>	Address
Immediately changes the I2C write address. Only even values are permitted as the next odd address will become the read address. Default is 80.			
Address	1 byte, even value		

<b>1.2. Changing the Baud Rate</b>	Dec	<b>254 57</b>	Speed
	Hex	<b>FE 39</b>	Speed
	ASCII	<b>■ 9</b>	Speed
Immediately changes the baud rate. Not available in I2C. Baud rate can be temporarily forced to 19200 by a manual override.			
Speed	1 byte, valid settings shown below		

Table 17: Accepted Baud Rate Values

<b>Rate</b>	1200	2400	4800	9600	19200	28800	38400	57600	115200
<b>Speed</b>	83	41	207	103	51	34	25	16	8

<b>1.3. Setting a Non-Standard Baud Rate</b>	Dec	<b>254 164</b>	Speed
	Hex	<b>FE A4</b>	Speed
Immediately changes the baud rate to a non-standard value. Speed must be a whole number between 977 and 153800. Due to rounding, error increases with baud rate, actual baud must be within 3% of desired baud to ensure accurate communication. Not available in I2C. Can be temporarily forced to 19200 by a manual override.			
Speed	2 bytes, calculations shown below, standard crystal speed is 16MHz		

$$Speed = \frac{CrystalSpeed}{(8 \times DesiredBaud)} - 1 \quad ActualBaud = \frac{CrystalSpeed}{(8 \times (Speed + 1))}$$

Equation 1: Speed Byte Calculation      Equation 2: Actual Baud Rate Calculation

$$\frac{|DesiredBaud - ActualBaud|}{DesiredBaud} < 0.03$$

Equation 3: Baud Rate Error Calculation

<b>1.4. Transmission Protocol Select</b>	Dec	<b>254 160</b>	Protocol
	Hex	<b>FE A0</b>	Protocol
Selects the protocol used for data transmission from the display. Data transmission to the display is not affected. Must be set to the protocol in use to receive data correctly.			
Protocol	1 byte, 1 for Serial (RS232/RS422/TTL/USB) or 0 for I2C		

## 2. Text

2.1. Auto Scroll On	Dec	<b>254 81</b>
	Hex	<b>FE 51</b>
	ASCII	<b>■ Q</b>

The entire contents of screen are shifted up one line when the end of the screen is reached. Default is on.

2.2. Auto Scroll Off	Dec	<b>254 82</b>
	Hex	<b>FE 52</b>
	ASCII	<b>■ R</b>

New text is written over the top line when the end of the screen is reached. Default is Auto Scroll on.

2.3. Clear Screen	Dec	<b>254 88</b>
	Hex	<b>FE 58</b>
	ASCII	<b>■ X</b>

Clears the contents of the screen.

2.4. Changing the Start Up Screen	Dec	<b>254 64</b>	<b>Characters</b>
	Hex	<b>FE 40</b>	<b>Characters</b>
	ASCII	<b>■ @</b>	<b>Characters</b>

Changes the message displayed on start up. Custom characters can be included by adding their decimal value (0-7). Characters will automatically wrap on the display.

**Characters** 80 bytes, space characters can be added as needed

2.5. Set Auto Line Wrap On	Dec	<b>254 67</b>
	Hex	<b>FE 43</b>
	ASCII	<b>■ C</b>

Text will wrap to the next consecutive line once a row becomes full. Default is Auto Line Wrap on.

2.6. Set Auto Line Wrap Off	Dec	<b>254 68</b>
	Hex	<b>FE 44</b>
	ASCII	<b>■ D</b>

Text will skip one line when wrapping once a row becomes full. Writing order will be rows 1, 3, 2, and then 4. Default is Auto Line Wrap on.

<b>2.7. Set Cursor Position</b>	Dec	<b>254 71</b>	Column Row
	Hex	<b>FE 47</b>	Column Row
	ASCII	<b>■ G</b>	Column Row
Sets the cursor to a specific position where the next transmitted character is printed.			
Column	1 byte, value between 1 and 20		
Row	1 byte, value between 1 and 4		

<b>2.8. Go Home</b>	Dec	<b>254 72</b>	
	Hex	<b>FE 48</b>	
	ASCII	<b>■ H</b>	
Returns the cursor to the top left of the screen.			

<b>2.9. Move Cursor Back</b>	Dec	<b>254 76</b>	
	Hex	<b>FE 4C</b>	
	ASCII	<b>■ L</b>	
Moves cursor one position to the left. Cursor will obey wrap settings.			

<b>2.10. Move Cursor Forward</b>	Dec	<b>254 77</b>	
	Hex	<b>FE 4D</b>	
	ASCII	<b>■ M</b>	
Moves cursor one position to the right. Cursor will obey wrap settings.			

<b>2.11. Underline Cursor On</b>	Dec	<b>254 74</b>	
	Hex	<b>FE 4A</b>	
	ASCII	<b>■ J</b>	
Displays a line under the current cursor position. Can be used with block cursor.			

<b>2.12. Underline Cursor Off</b>	Dec	<b>254 75</b>	
	Hex	<b>FE 4B</b>	
	ASCII	<b>■ K</b>	
Removes line under current cursor position.			



<b>2.13. Blinking Block Cursor On</b>	Dec	<b>254 83</b>
	Hex	<b>FE 53</b>
	ASCII	<b>■ S</b>

Displays a blinking block over the current cursor position. Can be used with underline.

<b>2.14. Blinking Block Cursor Off</b>	Dec	<b>254 84</b>
	Hex	<b>FE 54</b>
	ASCII	<b>■ T</b>

Removes blinking block over current cursor position.

### 3. Special Characters

<b>3.1. Creating a Custom Character</b>	Dec	<b>254 78</b>	ID Data
	Hex	<b>FE 4E</b>	ID Data
	ASCII	<b>■ N</b>	ID Data
Creates a custom character. Each character is divided into 8 rows of 5 pixels; each data byte represents one row. Each byte is padded by three zero bits followed by five bits representing each pixel state. A one represents an on condition while a zero is off. Characters are lost when a new memory bank is loaded, unless they are saved.			
ID	1 byte, character ID, value between 0 and 7		
Data	8 bytes, character pixel data as shown below		

Table 18: Custom Degree Character

Data1	000	p1	p2	p3	p4	p5	00001000	8
Data2	000	p1	p2	p3	p4	p5	00010100	20
Data3	000	p1	p2	p3	p4	p5	00001000	8
Data4	000	p1	p2	p3	p4	p5	00000011	3
Data5	000	p1	p2	p3	p4	p5	00000100	4
Data6	000	p1	p2	p3	p4	p5	00000100	4
Data7	000	p1	p2	p3	p4	p5	00000011	3
Data8	000	p1	p2	p3	p4	p5	00000000	0

<b>3.2. Saving Custom Characters</b>	Dec	<b>254 193</b>	Bank ID Data
	Hex	<b>FE C1</b>	Bank ID Data
Provides access to all memory banks to create and save custom characters, graph bars, and large digits. Any new characters saved will overwrite the old, so care should be taken when writing to any bar or digit memory bank. Bank structure is shown below.			
Bank	1 byte, memory bank ID, value between 0 and 4		
ID	1 byte, value between 0 and 7		
Data	8 bytes, character pixel data as above		

Table 19: Custom Character Banks

<b>0</b>	Start-up Characters	<b>1</b>	Horizontal Bars	<b>2</b>	Vertical Bars	<b>3</b>	Medium Digits	<b>4</b>	Large Digits
----------	---------------------	----------	-----------------	----------	---------------	----------	---------------	----------	--------------

<b>3.3. Loading Custom Characters</b>	Dec	<b>254 192</b>	Bank
	Hex	<b>FE C0</b>	Bank
Loads a bank of custom characters into memory for use. Must be issued before using a bank of characters. Alternatively, an appropriate initialize command can be used.			
Bank	1 byte, memory bank ID, value between 0 and 4		

<b>3.4. Save Start Up Screen Custom Characters</b>	Dec	<b>254 194</b>	ID Data
	Hex	<b>FE C2</b>	ID Data
Saves a custom character to memory for the start up screen or repeated use. Start up characters are displayed by sending their ID to the screen.			
ID	1 byte, value between 0 and 7		
Data	8 bytes, character pixel data, see custom character example		

<b>3.5. Initialize Medium Number</b>	Dec	<b>254 109</b>	
	Hex	<b>FE 6D</b>	
	ASCII	<b>■ m</b>	
Loads the medium number custom character bank into memory. Medium numbers must be initialized before use.			

<b>3.6. Place Medium Numbers</b>	Dec	<b>254 111</b>	Row Column Digit
	Hex	<b>FE 6F</b>	Row Column Digit
	ASCII	<b>■ o</b>	Row Column Digit
Places a single medium decimal digit of 2 row height and 1 column width on the display at the position specified. Medium numbers must be initialized before being placed.			
Row	1 byte, value between 1 and 20		
Column	1 byte, value between 1 and 4		
Digit	1 byte, single decimal digit to display		

<b>3.7. Initialize Large Numbers</b>	Dec	<b>254 110</b>	
	Hex	<b>FE 6E</b>	
	ASCII	<b>■ n</b>	
Loads the large number custom character bank into memory. Large numbers must be initialized before use.			

<b>3.8. Place Large Number</b>	Dec	<b>254 35</b>	Column Digit
	Hex	<b>FE 23</b>	Column Digit
	ASCII	<b>■ #</b>	Column Digit
Places a single large decimal digit, 4 rows in height and 3 columns in width, on the display at the position specified. Medium numbers must be initialized before being placed.			
Column	1 byte, value between 1 and 20		
Digit	1 byte, single decimal digit to display		

<b>3.9. Initialize Horizontal Bar</b>	Dec	<b>254 104</b>	
	Hex	<b>FE 68</b>	
	ASCII	<b>■ h</b>	
Loads the horizontal bar graph custom character bank into memory. Horizontal bar characters must be initialized before a graph is displayed.			

<b>3.10. Place Horizontal Bar Graph</b>	Dec	<b>254 124</b>	<b>Column Row Direction Length</b>
	Hex	<b>FE 7C</b>	<b>Column Row Direction Length</b>
	Places a horizontal bar graph on the screen beginning at the column and row specified. The bar extends either right or left to the length indicated. New bars will overwrite old.		
Column	1 byte, value between 1 and 20		
Row	1 byte, value between 1 and 4		
Direction	1 byte, 0 for right and 1 for left		
Length	1 byte, length in pixels of the graph, value between 0 and 100		

<b>3.11. Initialize Narrow Vertical Bar</b>	Dec	<b>254 115</b>	
	Hex	<b>FE 73</b>	
	ASCII	<b>■ s</b>	
Loads the narrow horizontal bar graph custom character bank into memory. A narrow bar is 2 pixels wide. Horizontal bar characters must be initialized before a graph is displayed.			

<b>3.12. Initialize Wide Vertical Bar</b>	Dec	<b>254 118</b>	
	Hex	<b>FE 76</b>	
	ASCII	<b>■ v</b>	
Loads the wide horizontal bar graph custom character bank into memory. A wide bar is 5 pixels wide. Horizontal bar characters must be initialized before a graph is displayed.			

<b>3.13. Place Vertical Bar</b>	Dec	<b>254 61</b>	<b>Column Length</b>
	Hex	<b>FE 3D</b>	<b>Column Length</b>
	ASCII	<b>■ =</b>	<b>Column Length</b>
Places a vertical bar graph on the screen extending from the first row of the column specified. The bar extends upwards to the length indicated. A new bar will over write the old.			
Column	1 byte, value between 1 and 20		
Length	1 byte, height in pixels of the graph, value between 0 and 32		

## 4. General Purpose Output

<b>4.1. General Purpose Output Off</b>	Dec	<b>254 86</b>	Number
	Hex	<b>FE 56</b>	Number
	ASCII	<b>■ V</b>	Number
Turns the specified GPO off, sinking current to an output of zero volts.			
Number	1 byte, GPO to be turned off, value between 1 and 6		

<b>4.2. General Purpose Output On</b>	Dec	<b>254 87</b>	Number
	Hex	<b>FE 57</b>	Number
	ASCII	<b>■ W</b>	Number
Turns the specified GPO on, sourcing current from an output of five volts.			
Number	1 byte, GPO to be turned on, value between 1 and 6		

<b>4.3. Set Start Up GPO State</b>	Dec	<b>254 195</b>	Number State
	Hex	<b>FE C3</b>	Number State
Sets and saves the start up state of the specified GPO in non volatile memory. Changes will be seen on start up.			
Number	1 byte, GPO to be controlled, value between 1 and 6		
State	1 byte, 1 for on or 0 for off		

## 5. Dallas One-Wire

<b>5.1. Search for a One-Wire Device</b>	Dec <b>254 200 2</b> Hex <b>FE C8 02</b>
Sends a search query to each of the up to 32 devices on the one wire bus. Any connected device will respond with an identification packet.	
<b>Response</b>	14 bytes, identification packet as shown below

Table 20: Dallas One-Wire Packet Information

Offset	Length	Value	Description
0	2	9002	Preamble
2	1	138	Another device packet will follow <b>OR</b>
		10	Last device packet
3	1	49	Packet Type
4	1	0	Error Code (0 indicates success)
5	8		Device Address
13	1	0	CRC8 address check (0 indicates validity)

<b>5.2. Dallas One-Wire Transaction</b>	Dec <b>254 200 1</b> Hex <b>FE C8 01</b>	<b>Flags Send Bits Receive Bits Data</b> <b>Flags Send Bits Receive Bits Data</b>
Performs a single Dallas 1-Wire transaction. Consult your device documentation for information regarding device specific protocols. If an error is encountered, a corresponding value will be returned by the device.		
<b>Flags</b>	1 byte, flags for transaction, see below	
<b>Send Bits</b>	1 byte, number of bytes to be sent to the device	
<b>Receive Bits</b>	1 byte, number of bytes expected to be received from the device	
<b>Data</b>	Variable, data to be transmitted LSB to MSB	

Table 21: Dallas One-Wire Flag Table

Bit	Flag Description
7	
6	Unused
5	
4	0 (Future Compatibility)
3	Add CRC8 to transaction
2	0 (Future Compatibility)
1	Read CRC8 from transaction
0	Reset Bus prior to transaction

Table 22: Dallas One-Wire Error Table

Code	Error Description
0	Success
1	Unknown Command
2	No Devices Found
3	Fatal Search Error

## 6. Keypad

<b>6.1. Auto Transmit Key Presses On</b>	Dec	<b>254 65</b>
	Hex	<b>FE 41</b>
	ASCII	<b>■ A</b>

Key presses are automatically sent to the host when received by the display. Default is Auto Transmit on.

<b>6.2. Auto Transmit Key Presses Off</b>	Dec	<b>254 79</b>
	Hex	<b>FE 4F</b>
	ASCII	<b>■ O</b>

Key presses are held in the 10 key buffer to be polled by the host using the Poll Key Press command. Use this mode for I2C transactions. Default is Auto Transmit on.

<b>6.3. Poll Key Press</b>	Dec	<b>254 38</b>
	Hex	<b>FE 26</b>
	ASCII	<b>■ &amp;</b>

Reads the last unread key press from the 10 key display buffer. If another key is stored in the buffer the MSB will be 1, the MSB will be 0 when the last key press is read. If there are no stored key presses a value of 0 will be returned. Auto transmit key presses must be turned off for this command to be successful.

**Response** | 1 byte, value of key pressed (MSB determines additional keys to be read)

<b>6.4. Clear Key Buffer</b>	Dec	<b>254 69</b>
	Hex	<b>FE 45</b>
	ASCII	<b>■ E</b>

Clears all key presses from the key buffer.

<b>6.5. Set Debounce Time</b>	Dec	<b>254 85</b>	<b>Time</b>
	Hex	<b>FE 55</b>	<b>Time</b>
	ASCII	<b>■ U</b>	<b>Time</b>

Sets the time between a key press and a key read by the display. Most switches will bounce when pressed; the debounce time allows the switch to settle for an accurate read. Default is 8 representing a debounce time of approximately 52ms.

**Time** | 1 byte, debounce increment (debounce time = **Time** \* 6.554ms)

<b>6.6. Set Auto Repeat Mode</b>	Dec	<b>254 126</b>	Mode
	Hex	<b>FE 7E</b>	Mode
Sets key press repeat mode to typematic or hold. In typematic mode if a key press is held, the key value is transmitted immediately, then 5 times a second after a 1 second delay. In hold mode, the key down value is transmitted once when pressed, and then the key up value is sent when the key is released. Default is typematic.			
Mode	1 byte, 1 for hold mode or 0 for typematic		

<b>6.7. Auto Repeat Mode Off</b>	Dec	<b>254 96</b>
	Hex	<b>FE 60</b>
Turns auto repeat mode off. Default is on (typematic).		

<b>6.8. Assign Keypad Codes</b>	Dec	<b>254 213</b>	Key Down Key Up
	Hex	<b>FE D5</b>	Key Down Key Up
Assigns the key down and key up values sent to the host when a key press is detected. A key up and key down value must be sent for every key, a value of 255 will leave the key unaltered. Defaults are shown below.			
Key Down	25 bytes, key down values, beginning at row one column one moving right then down.		
Key Up	25 bytes, key up values, beginning at row one column one moving right then down.		

Table 23: Default Key Down Values

Key Down				
A(65)	B(66)	C(67)	D(68)	E(69)
F(70)	G(71)	H(72)	I(73)	J(74)
K(75)	L(76)	M(77)	N(78)	O(79)
P(80)	Q(81)	R(82)	S(83)	T(84)
U(85)	V(86)	W(87)	X(88)	Y(89)

Table 24: Default Key Up Values

Key Up				
a(97)	b(98)	c(99)	d(100)	e(101)
f(102)	g(103)	h(104)	i(105)	j(106)
k(107)	l(108)	m(109)	n(110)	o(111)
p(112)	q(113)	r(114)	s(115)	t(116)
u(117)	v(118)	w(119)	x(120)	y(121)



## 7. Display Functions

<b>7.1. Display On</b>	Dec	<b>254 66</b>	Minutes
	Hex	<b>FE 42</b>	Minutes
	ASCII	<b>■ B</b>	Minutes
Turns the display backlight on for a specified length of time. If an inverse display color is used this command will essentially turn on the text.			
<b>Minutes</b>	1 byte, number of minutes to leave backlight on, a value of 0 leaves the display on indefinitely		

<b>7.2. Display Off</b>	Dec	<b>254 70</b>	
	Hex	<b>FE 46</b>	
	ASCII	<b>■ F</b>	
Turns the display backlight off. If an inverse display colour is used this command will turn off the text.			

<b>7.3. Set Brightness*</b>	Dec	<b>254 153</b>	Brightness
	Hex	<b>FE 99</b>	Brightness
Immediately sets the backlight brightness. If an inverse display color is used this represents the text colour intensity instead. Default is 255.			
<b>Brightness</b>	1 byte, brightness level from 0(Dim) to 255(Bright)		

<b>7.4. Set and Save Brightness*</b>	Dec	<b>254 152</b>	Brightness
	Hex	<b>FE 98</b>	Brightness
Immediately sets and saves the backlight brightness. Although brightness can be changed using the set command, it is reset to the saved value on start up. Default is 255.			
<b>Brightness</b>	1 byte, brightness level from 0(Dim) to 255(Bright)		

<b>7.5. Set Contrast*</b>	Dec	<b>254 80</b>	Contrast
	Hex	<b>FE 50</b>	Contrast
	ASCII	<b>■ P</b>	Contrast
Immediately sets the contrast between background and text. If an inverse display color is used this also represents the text brightness. Default is 128.			
<b>Contrast</b>	1 byte, contrast level from 0(Light) to 255(Dark)		

<b>7.6. Set and Save Contrast*</b>	Dec	<b>254 145</b>	Contrast
	Hex	<b>FE 91</b>	Contrast
Immediately sets and saves the contrast between background and text. Although contrast can be changed using the set command, it is reset to this saved value on start up. Default is 128.			
<b>Contrast</b>	1 byte, contrast level from 0(Light) to 255(Dark)		

<b>7.7. Set VFD Brightness**</b>	Dec	<b>254 89</b>	Brightness
	Hex	<b>FE 59</b>	Brightness
	ASCII	<b>■ Y</b>	Brightness
Immediately sets the text brightness. Default is 0.			
Brightness	1 byte, brightness level from 3(Dim) to 0(Bright)		

<b>7.8. Set and Save VFD Brightness**</b>	Dec	<b>254 145</b>	Brightness
	Hex	<b>FE 91</b>	Brightness
Immediately sets and saves the text brightness. Although brightness can be changed using the set command, it is reset to the saved value on start up. Default is 0.			
Brightness	1 byte, brightness level from 3(Dim) to 0(Bright)		

**\*Note:** LCD Model specific command.

**\*\*Note:** VFD Model specific command.

## 8. Data Security

<b>8.1. Set Remember</b>	Dec	<b>254 147</b>	Switch
	Hex	<b>FE 93</b>	Switch
Allows changes to specific settings to be saved to the display memory. Writing to non-volatile memory can be slow and each change consumes 1 write of approximately 100,000 available. The Command Summary outlines which commands are saved always, never, and when this command is on only. Remember is off by default.			
Switch	1 byte, 1 for on or 0 for off		

<b>8.2. Set Data Lock</b>	Dec	<b>254 202 245 160</b>	Level
	Hex	<b>FE CA F5 A0</b>	Level
Temporarily locks certain aspects of the display to ensure no inadvertent changes are made. The lock is released after a power cycle. A new level overrides the old, and levels can be combined. Default is 0.			
Level	1 byte, each bit representing a level, see Table 25		

Table 25: Data Lock Bits

Display	Command	Reserved	Setting	Address	Reserved	Reserved	Reserved
7	6	5	4	3	2	1	0

Table 26: Lock Parameters

Reserved	Place holders only, should be 0
Address	Locks the Baud Rate and I <sup>2</sup> C address
Setting	Locks all settings from being saved
Command	Locks all commands, text can still be written
Display	Locks entire display, no new text can be displayed

<b>8.3. Set and Save Data Lock</b>	Dec	<b>254 203 245 160</b>	Level
	Hex	<b>FE CB F5 A0</b>	Level
Locks certain aspects of the display to ensure no inadvertent changes are made. The lock is not affected by a power cycle. A new level overrides the old, and levels can be combined. Default is 0.			
Level	1 byte, see data lock table		

## 9. Miscellaneous

<b>9.1. Write Customer Data</b>	Dec	<b>254 52</b>	Data
	Hex	<b>FE 34</b>	Data
	ASCII	<b>■ 4</b>	Data
Saves a user defined block of data to non-volatile memory. Useful for storing display information for later use.			
<b>Data</b>	16 bytes, user defined data		

<b>9.2. Read Customer Data</b>	Dec	<b>254 53</b>
	Hex	<b>FE 35</b>
	ASCII	<b>■ 5</b>
Reads data previously written to non-volatile memory. Data is only changed when written, surviving power cycles.		
<b>Response</b>	16 bytes, previously saved user defined data	

<b>9.3. Read Version Number</b>	Dec	<b>254 54</b>
	Hex	<b>FE 36</b>
	ASCII	<b>■ 6</b>
Causes display to respond with its firmware version number.		
<b>Response</b>	1 byte, convert to hexadecimal to view major and minor revision numbers	

<b>9.4. Read Module Type</b>	Dec	<b>254 55</b>
	Hex	<b>FE 37</b>
	ASCII	<b>■ 7</b>
Causes display to respond with its module number.		
<b>Response</b>	1 byte, module number, see partial list below	

Table 27: Sample Module Type Responses

<b>9</b>	LK204-25	<b>15</b>	VK204-25
<b>87</b>	LK204-25-USB	<b>88</b>	VK204-25-USB
<b>89</b>	LK204-25-422	<b>90</b>	VK204-25-422

## Appendix

### Command Summary

Available commands below include identifying number, required parameters, the returned response and an indication of whether the setting is remembered always, never, or with remember set to on.

Table 28: Communication Command Summary

Name	Dec	Hex	ASCII	Parameters	Response	Remembered
Changing the I2C Slave Address	51	33	3	Address	None	Always
Changing the Baud Rate	57	39	9	BaudRate	None	Always
Setting a Non-Standard Baud Rate	164	A4	ñ	Speed[2]	None	Always
Transmission Protocol Select	160	A0	á	Protocol	None	Remember On

Table 29: Text Command Summary

Name	Dec	Hex	ASCII	Parameters	Response	Remembered
Auto Scroll On	81	51	Q	None	None	Remember On
Auto Scroll Off	82	52	R	None	None	Remember On
Clear Screen	88	58	X	None	None	Never
Changing the Start Up Screen	64	40	@	Characters [80]	None	Always
Set Auto Line Wrap On	67	43	C	None	None	Remember On
Set Auto Line Wrap Off	68	44	D	None	None	Remember On
Set Cursor Position	71	47	G	Col, Row	None	Never
Go Home	72	48	H	None	None	Never
Move Cursor Back	76	4C	L	None	None	Never
Move Cursor Forward	77	4D	M	None	None	Never
Underline Cursor On	74	4A	J	None	None	Remember On
Underline Cursor Off	75	4B	K	None	None	Remember On
Blinking Block Cursor On	83	53	S	None	None	Remember On
Blinking Block Cursor Off	84	54	T	None	None	Remember On

Table 30: Special Character Command Summary

Name	Dec	Hex	ASCII	Parameters	Response	Remembered
Creating a Custom Character	78	4E	N	ID, Data [8]	None	Remember On
Saving Custom Characters	193	C1	⊥	Bank, ID, Data [8]	None	Always
Loading Custom Characters	192	C0	└	Bank	None	Never
Save Start Up Screen Custom Characters	194	C2	┘	ID, Data [8]	None	Always
Initialize Medium Number	109	6D	m	None	None	Never
Place Medium Numbers	111	6F	o	Row, Col, Digit	None	Never
Initialize Large Numbers	110	6E	n	None	None	Never
Place Large Number	35	23	#	Col, Digit	None	Never
Initialize Horizontal Bar	104	68	h	None	None	Never
Place Horizontal Bar Graph	124	7C		Col, Row, Dir, Length	None	Never
Initialize Narrow Vertical Bar	115	73	s	None	None	Never
Initialize Wide Vertical Bar	118	76	v	None	None	Never
Place Vertical Bar	61	3D	=	Col, Length	None	Never

Table 31: General Purpose Output Command Summary

Name	Dec	Hex	ASCII	Parameters	Response	Remembered
General Purpose Output Off	86	56	V	Number	None	Never
General Purpose Output On	87	57	W	Number	None	Never
Set Start Up GPO State	195	C3	├	Number, State	None	Always

Table 32: Dallas One-Wire Command Summary

Name	Dec	Hex	ASCII	Parameters	Response	Remembered
Search for a One-Wire Device	200, 2	C8, 02	⌞, ☉	None	Data [14]	Never
Dallas One-Wire Transaction	200, 1	C8, 01	⌞, ☺	Flags, Send, Receive, Data []	Data []	Never

Table 33: Keypad Command Summary

Name	Dec	Hex	ASCII	Parameters	Response	Remembered
Auto Transmit Key Presses On	65	41	A	None	None	Remember On
Auto Transmit Key Presses Off	79	4F	O	None	None	Remember On
Poll Key Press	38	26	&	None	KeyPress	Never
Clear Key Buffer	69	45	E	None	None	Never
Set Debounce Time	85	55	U	Time	None	Remember On
Set Auto Repeat Mode	126	7E	~	Mode	None	Remember On
Auto Repeat Mode Off	96	60	`	None	None	Remember On
Assign Keypad Codes	213	D5	┐	KeyUp [25], KeyDown [25]	None	Always

Table 34: Display Functions Command Summary

Name	Dec	Hex	ASCII	Parameters	Response	Remembered
Display On	66	42	B	Minutes	None	Remember On
Display Off	70	46	F	None	None	Remember On
Set Brightness*	153	99	Ö	Brightness	None	Remember On
Set and Save Brightness*	152	98	ÿ	Brightness	None	Always
Set Contrast*	80	50	P	Contrast	None	Remember On
Set and Save Contrast*	145	91	æ	Contrast	None	Always
Set VFD Brightness**	89	59	Y	Brightness	None	Remember On
Set and Save VFD Brightness**	145	91	æ	Brightness	None	Always

Note\*: LCD Model specific command.

Note\*\*: VFD Model specific command.

Table 35: Data Security Command Summary

Name	Dec	Hex	ASCII	Parameters	Response	Remembered
Set Remember	147	93	ô	Switch	None	Always
Set Data Lock	202, 245, 160	CA, F5, A0	⌞,  , á	Level	None	Remember On
Set and Save Data Lock	203, 245, 160	CB, F5, A0	⌞,  , á	Level	None	Always

Table 36: Miscellaneous Command Summary

Name	Dec	Hex	ASCII	Parameters	Response	Remembered
Write Customer Data	52	34	4	Data [16]	None	Always
Read Customer Data	53	35	5	None	Data [16]	Never
Read Version Number	54	36	6	None	Version	Never
Read Module Type	55	37	7	None	Module	Never

## Character Sets

		Higher 4-bit (D4 to D7) of Character Code (Hexadecimal)															
		0	1	2	3	4	5	6	7	8	9	A	B	C	D	E	F
Lower 4-bit (D0 to D3) of Character Code (Hexadecimal)	0	CG RAM (1)	⊕		0	P	P	P	P	P	P	P	P	P	P	P	P
	1	CG RAM (2)	⊖	.	1	A	a	a	a	a	a	a	a	a	a	a	a
	2	CG RAM (3)	∇	"	2	B	b	b	b	b	b	b	b	b	b	b	b
	3	CG RAM (4)	⊙	#	3	S	s	s	s	s	s	s	s	s	s	s	s
	4	CG RAM (5)	⊕	\$	4	D	t	t	t	t	t	t	t	t	t	t	t
	5	CG RAM (6)	⊖	%	5	E	e	e	e	e	e	e	e	e	e	e	e
	6	CG RAM (7)	∇	&	6	F	v	v	v	v	v	v	v	v	v	v	v
	7	CG RAM (8)	⊙	'	7	G	w	w	w	w	w	w	w	w	w	w	w
	8	CG RAM (1)	⊕	(	8	H	x	x	x	x	x	x	x	x	x	x	x
	9	CG RAM (2)	⊖	)	9	I	y	y	y	y	y	y	y	y	y	y	y
	A	CG RAM (3)	∇	*		J	z	z	z	z	z	z	z	z	z	z	z
	B	CG RAM (4)	⊙	+		K	c	c	c	c	c	c	c	c	c	c	c
	C	CG RAM (5)	⊕	,	<	L	i	i	i	i	i	i	i	i	i	i	i
	D	CG RAM (6)	⊖	-	=	M	m	m	m	m	m	m	m	m	m	m	m
	E	CG RAM (7)	∇	.	>	N	n	n	n	n	n	n	n	n	n	n	n
	F	CG RAM (8)	⊙	/	?	O	_	_	_	_	_	_	_	_	_	_	_

Figure 21: LCD Model European Character Set

		Higher 4-bit (D4 to D7) of Character Code (Hexadecimal)																				
		0	1	2	3	4	5	6	7	8	9	A	B	C	D	E	F					
Lower 4-bit (D0 to D3) of Character Code (Hexadecimal)	0	CG RAM (1)			0	1	2	3	4	5	6	7	8	9	A	B	C	D	E	F		
	1	CG RAM (2)		!	!	!	!	!	!	!	!	!	!	!	!	!	!	!	!	!	!	
	2	CG RAM (3)		"	"	"	"	"	"	"	"	"	"	"	"	"	"	"	"	"	"	
	3	CG RAM (4)		#	#	#	#	#	#	#	#	#	#	#	#	#	#	#	#	#	#	
	4	CG RAM (5)		\$	\$	\$	\$	\$	\$	\$	\$	\$	\$	\$	\$	\$	\$	\$	\$	\$	\$	
	5	CG RAM (6)		%	%	%	%	%	%	%	%	%	%	%	%	%	%	%	%	%	%	%
	6	CG RAM (7)		&	&	&	&	&	&	&	&	&	&	&	&	&	&	&	&	&	&	&
	7	CG RAM (8)		'	'	'	'	'	'	'	'	'	'	'	'	'	'	'	'	'	'	'
	8	CG RAM (1)		(	(	(	(	(	(	(	(	(	(	(	(	(	(	(	(	(	(	(
	9	CG RAM (2)		)	)	)	)	)	)	)	)	)	)	)	)	)	)	)	)	)	)	)
	A	CG RAM (3)		*	*	*	*	*	*	*	*	*	*	*	*	*	*	*	*	*	*	*
	B	CG RAM (4)		+	+	+	+	+	+	+	+	+	+	+	+	+	+	+	+	+	+	+
	C	CG RAM (5)		,	,	,	,	,	,	,	,	,	,	,	,	,	,	,	,	,	,	,
	D	CG RAM (6)		-	-	-	-	-	-	-	-	-	-	-	-	-	-	-	-	-	-	-
	E	CG RAM (7)		.	.	.	.	.	.	.	.	.	.	.	.	.	.	.	.	.	.	.
	F	CG RAM (8)		/	/	/	/	/	/	/	/	/	/	/	/	/	/	/	/	/	/	/

Figure 22: VFD Model Japanese Character Set



## Environmental Specifications

Table 37: Environmental Limits

	LCD Standard	LCD Extended (-E)	VFD Standard	VFD Extended (-E)
Operating Temperature	0°C to +50°C	-20°C to +70°C	-20°C to +70°C	-40°C to +85°C
Storage Temperature	-10°C to +60°C	-30°C to +80°C	-40°C to +85°C	-50°C to +85°C
Operating Relative Humidity	Maximum 90% non-condensing		Maximum 80% non-condensing	
Thermal Shock	Maximum 10°C/min			

## Electrical Tolerances

### Current Consumption

Table 38: Current Consumption

Board	+	Backlight	+	GPOs
40mA		70 to 150 mA		20mA each maximum

Table 39: Backlight Current Draw

YG & IY	R	GW & WB	VFD
135mA	150mA	70mA	250mA

### Input Voltage Specifications

Table 40: Voltage Specifications

Standard*	Wide Voltage (-V)*	Extended Wide Voltage (-VPT)
4.75-5.25V	9.0-15.0V	9.0-35.0V

\*Note: Standard and Wide Voltage variants of the RS422 model should be powered from a local source only.

## Optical Characteristics

Table 41: Display Optics

	LCD Model	VFD Model	
Module Size	98.00 x 60.00 x 30.5		mm
Viewing Area	76.0 x 25.2	70.8 x 20.9	mm
Active Area	70.4 x 20.8	N/A	mm
Character Size	2.95 x 4.75	2.40 x 4.70	mm
Character Pitch	3.55 x 5.35	3.60 x 5.40	mm
Pixel Size	0.55 x 0.55	0.40 x 0.50	mm
Pixel Pitch	0.60 x 0.60	0.50 x 0.70	mm
Viewing Direction	12	N/A	O'clock
Viewing Angle	-30 to +30	N/A	°
Contrast Ratio	3	N/A	
	N/A	350	cd/m <sup>2</sup>
Backlight Half-Life	50,000	N/A	Hours

## Dimensional Drawings

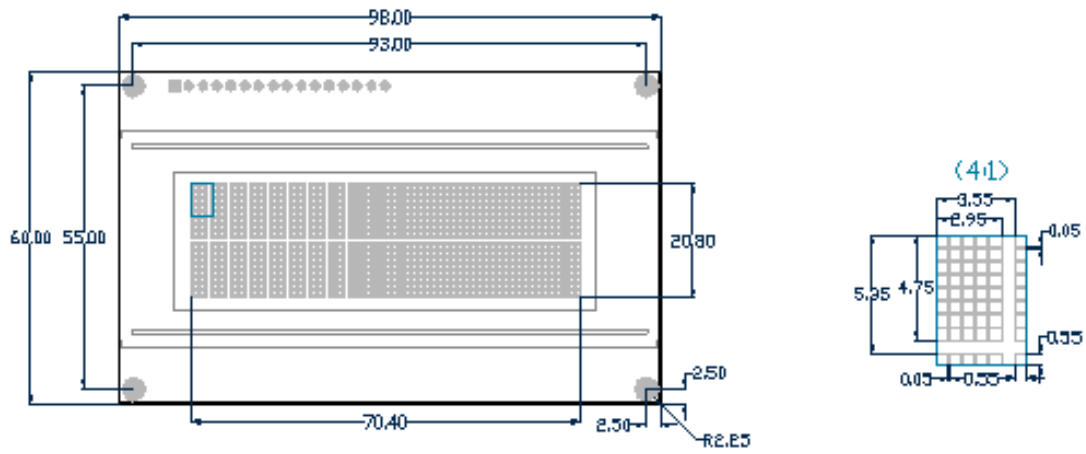

Figure 23: LCD Dimensional Drawing

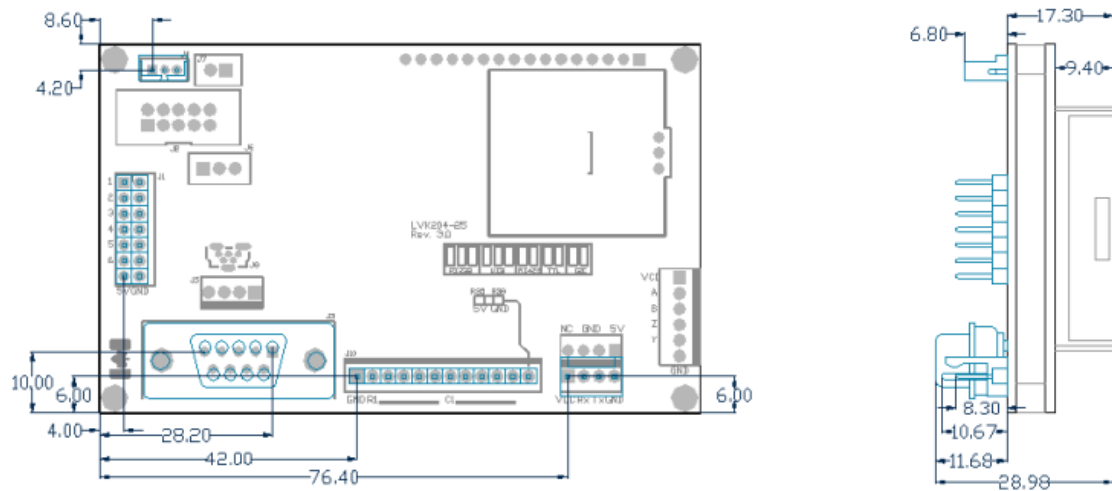

Figure 24: LVK204-25 Dimensional Drawing

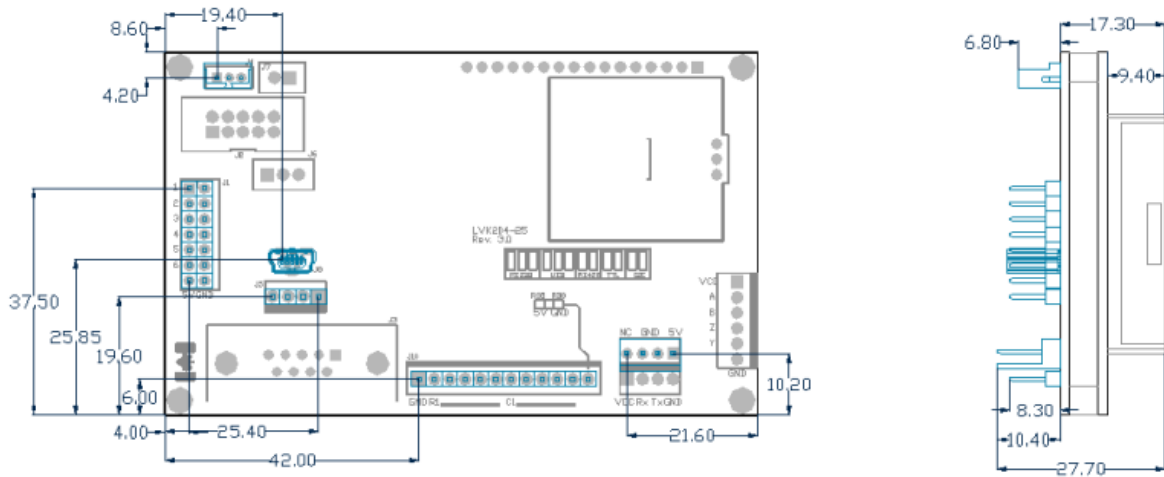

Figure 25: LVK204-25-USB Dimensional Drawing

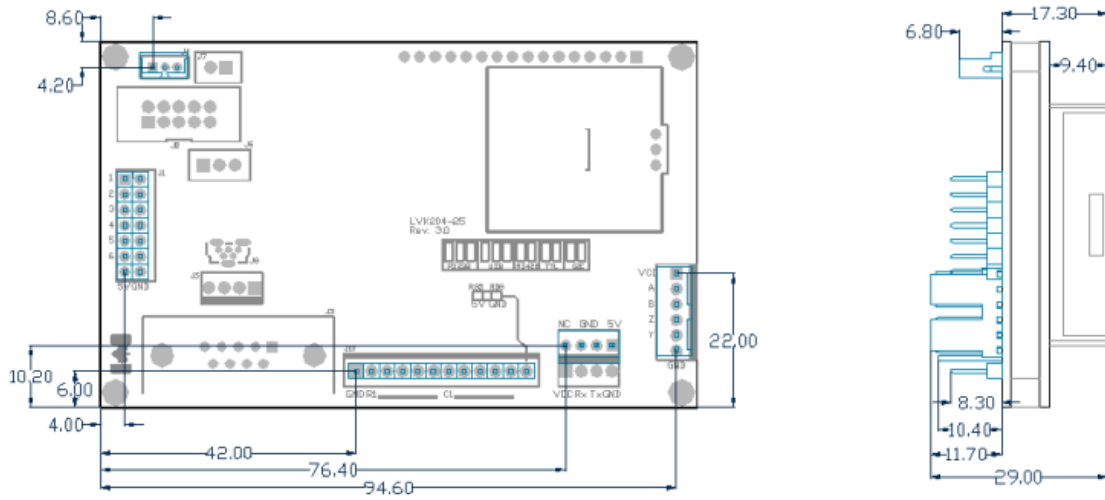

Figure 26: LVK204-25-422 Dimensional Drawing

# Ordering

## Part Numbering Scheme

Table 42: Part Numbering Scheme

LK	-204	-25	-R	-VPT	-422	-E
1	2	3	4	5	6	7

## Options

Table 43: Display Options

#	Designator	Options
1	Product Type	LK: Liquid Crystal Display with Keypad Input VK: Vacuum Florescent Display with Keypad Input
2	Display Size	-204: 20 columns by 4 rows
3	Keypad Size	-25: 25 key maximum
4	Colour	NP: Standard (YG for LCD/ no filter for VFD) -GW: Grey Text with White Background -WB: White Test with Blue Background -IY: Yellow-Green Text with Black Background (Inverse Display) -R: Red Text with Black Background (Inverse Display)
5	Voltage	NP: Standard Voltage -V: Wide Voltage* -VPT: Wide Voltage with Efficient Switching Power Supply
6	Protocol	NP: Standard Model -USB: USB Only Model -422: RS422 Only Model**
7	Temperature	NP: Standard -E: Extended Temperature

**\*Note:** Input voltage for Wide Voltage (-V) models may be limited by PCN 2011-06-03-01.

**\*\*Note:** The RS422 model should only be powered from a local source, unless the -VPT variant is used.

## Accessories





### Power

Table 44: Power Accessories

PCS	Standard Power Cable	
-----	----------------------	-------------------------------------------------------------------------------------

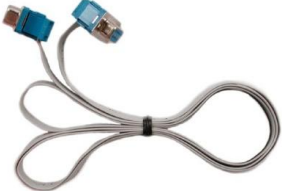

### Communication

Table 45: Communication Accessories

CSS4FT	4 ft. Serial Cable	
EXTMUSB3FT	Mini-USB Cable	
INTMUSB3FT	Internal Mini-USB Cable	
SCCPC5V	Serial Communication/5V Power Cable	
BBC	Breadboard Cable	

## Peripherals

Table 46: Peripheral Accessories

KPP4x4	16 Button Keypad	
KPP204A-XX*	15 Button Keypad Overlay	
Temperature Probe	Dallas One-Wire Temperature Probe	

## Mounting

Table 47: Mounting Accessories

B2041-XX**	Mounting Bracket with Coloured Overlay	
B204A-XX*	Mounting Bracket with Keyed Overlay	
MK2041-XX**	Coloured Overlay with Drill Guide	

**Note\*:** Keyed overlays are available in Black Vinyl (-BK) and Beige Vinyl (no part extension).

**Note\*\*:** Non-keyed overlays are available in Black Vinyl (-BK), Black Brushed Aluminum (-BL), Silver Brushed Aluminum (-AL), and Beige Vinyl (no part extension).

## Definitions

ASCII: American standard code for information interchange used to give standardized numeric codes to alphanumeric characters.

BPS: Bits per second, a measure of transmission speed.

DOW: Dallas One-Wire protocol, similar to I<sup>2</sup>C, provides reduced data rates at a greater distance. One wire carries data, while two others supply power and ground. Matrix Orbital tests non-parasitic devices only, those that do not draw power from the data line; however, some parasitic devices may work.

FFSTN: Double film super-twisted nematic in reference to an LCD. The addition of two layers of film between the STN display and polarizer improves contrast.

GPO: General purpose output, used to control peripheral devices from a display.

GUI: Graphical user interface.

Hexadecimal: A base 16 number system utilizing symbols 0 through F to represent the values 0-15.

I<sup>2</sup>C: Inter-integrated circuit protocol uses clock and data lines to communicate short distances at slow speeds from a master to up to 128 addressable slave devices. A display is a slave device.

LSB: Least significant bit or byte in a transmission, the rightmost when read.

MSB: Most significant bit or byte in a transmission, the leftmost when read.

RS232: Recommended standard 232, a common serial protocol. A low level is -30V, a high is +30V.

RS422: Recommended standard 422, a more robust differential pair serial protocol.

SDA: Serial data line used to transfer data in I<sup>2</sup>C protocol. This open drain line should be pulled high through a resistor. Nominal values are between 1K and 10K  $\Omega$ .

SCL: Serial clock line used to designate data bits in I<sup>2</sup>C protocol. This open drain line should be pulled high through a resistor. Nominal values are between 1K and 10K  $\Omega$ .

STN: Super-twisted nematic in reference to an LCD. In a relaxed or nematic state, crystals orientate themselves in the same direction and pass light. In an excited state these crystals align to block light. Super-twisted crystals move from 180 to 270 degrees between to increase contrast over TN models.

TTL: Transistor-transistor logic applied to serial protocol. Low level is 0V while high logic is 5V.

## Contact

### Sales

Phone: 403.229.2737

Email: [sales@matrixorbital.ca](mailto:sales@matrixorbital.ca)

### Support

Phone: 403.204.3750

Email: [support@matrixorbital.ca](mailto:support@matrixorbital.ca)

### Online

Purchasing: [www.matrixorbital.com](http://www.matrixorbital.com)

Support: [www.matrixorbital.ca](http://www.matrixorbital.ca)